



# TRANSPORTATION COMPONENTS



WWW.TRANCOM.CO.ZA

JHB: 011 444 0088

DBN: 031 463 2461

## HEAVY COMMERCIAL VEHICLE COMPONENT CATALOGUE 2020/21



## INDEX

<u>GROUP</u>		<u>PAGES</u>
HOW TO MEASURE	3	7
AMERICAN GROUP	8	22
BELL GROUP	23	25
BMC GROUP	26	27
BOMAG GROUP	28	29
CATERPILLAR GROUP	30	31
DAF GROUP	32	37
DEUTZ GROUP	38	39
DYNAPAC GROUP	40	41
ERF GROUP	42	43
FAW GROUP	44	45
FORKLIFT GROUP	46	47
FUSO GROUP	48	49
HINO GROUP	50	51
HYSTER GROUP	52	53
INGERSOL RAND GROUP	54	55
IVECO GROUP	56	60
KOMATSU GROUP	61	62
LEYLAND GROUP	63	64
MAN GROUP	65	92
MERCEDES GROUP	93	120
NISSAN GROUP	121	122
PERKINS ENGINE GROUP	123	124
RENAULT GROUP	125	128
SCANIA GROUP	129	137
TATA GROUP	138	139
TEREX GROUP	140	141
VOLVO GROUP	142	158
OTHER / UNIVERSAL GROUP	159	161
TRAILER GROUP	162	166
DUROLINE	167	167

# HOW TO MEASURE

## FAN OUTER DIAMETER

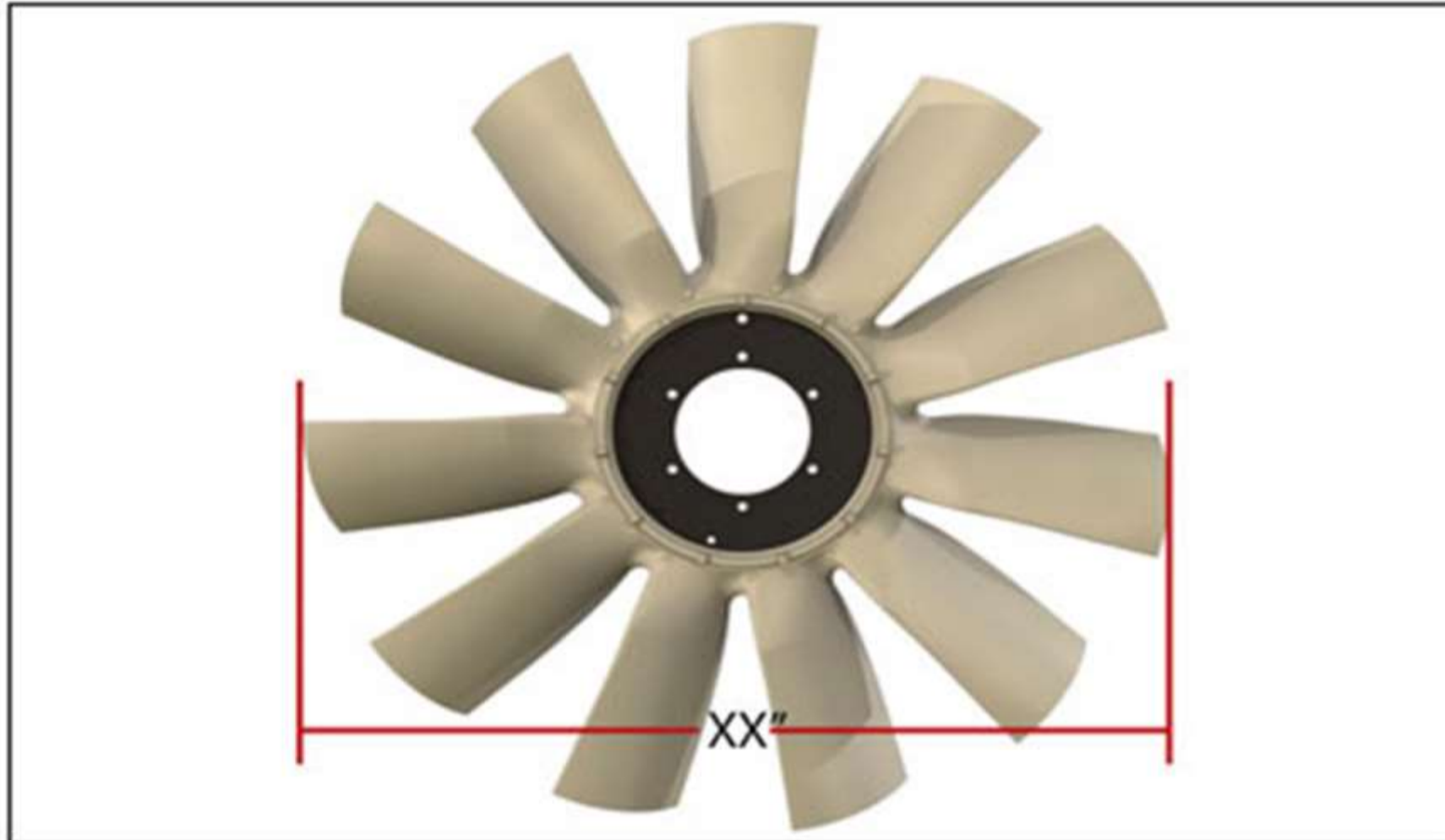

## FAN PILOT / INNER DIAMETER

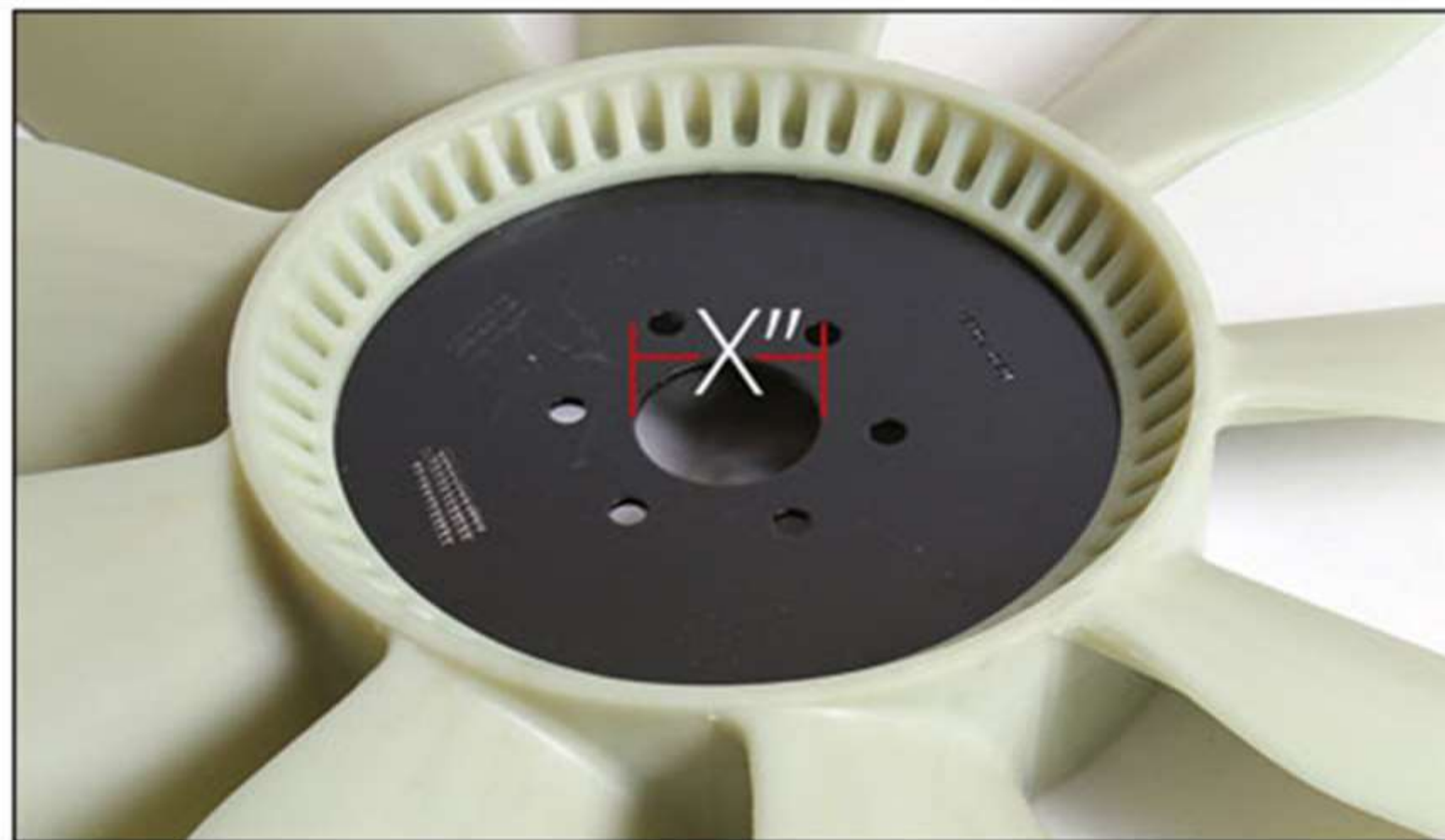

# HOW TO MEASURE

## PCD (PITCH CIRCLE DIAMETER)

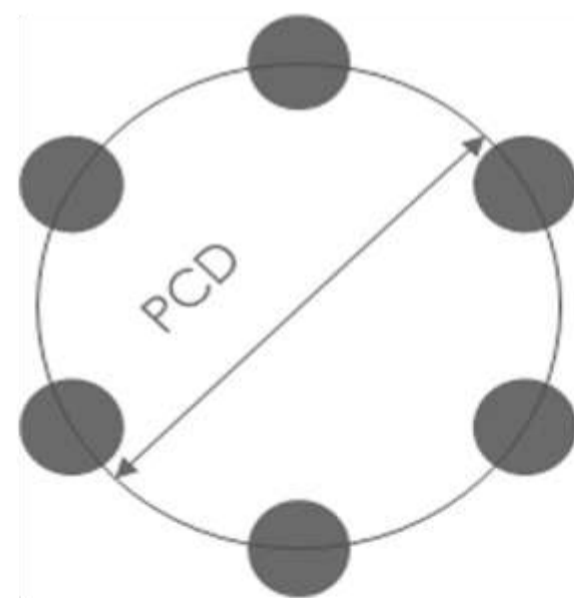
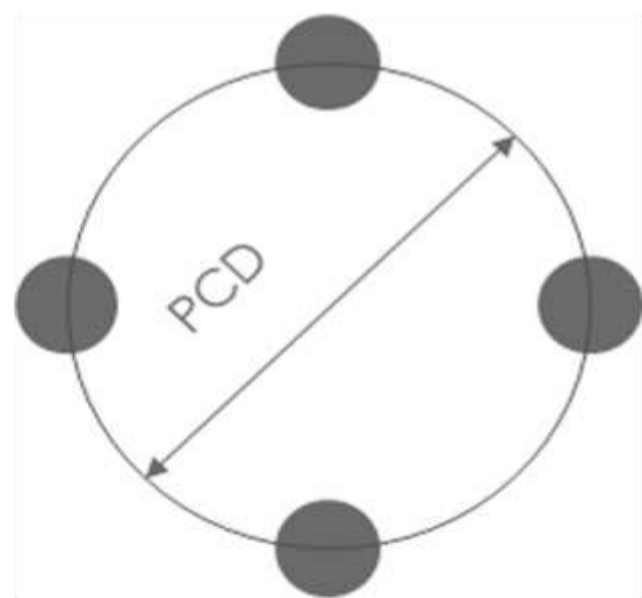
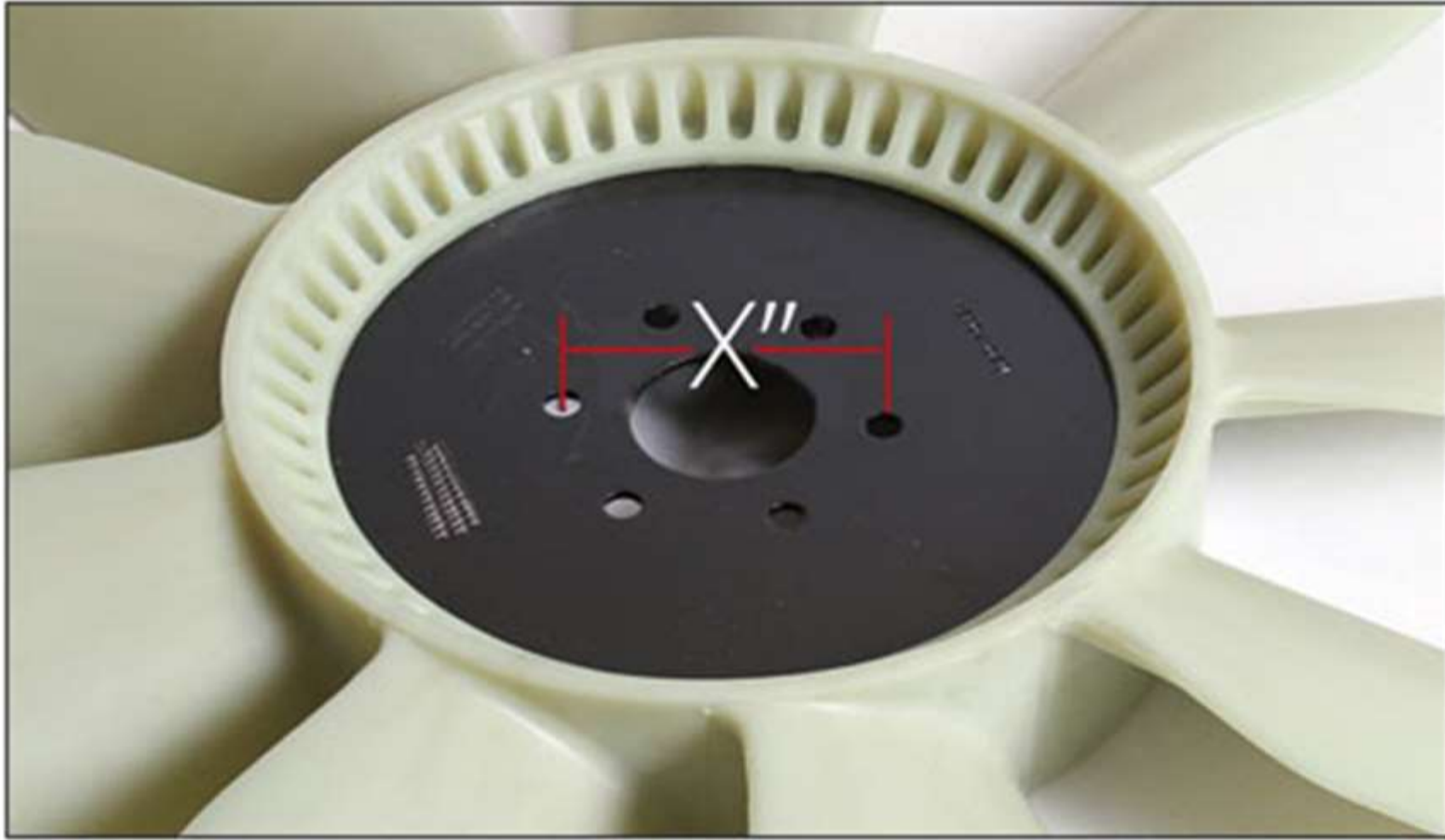

# HOW TO IDENTIFY

## SUCTION FAN

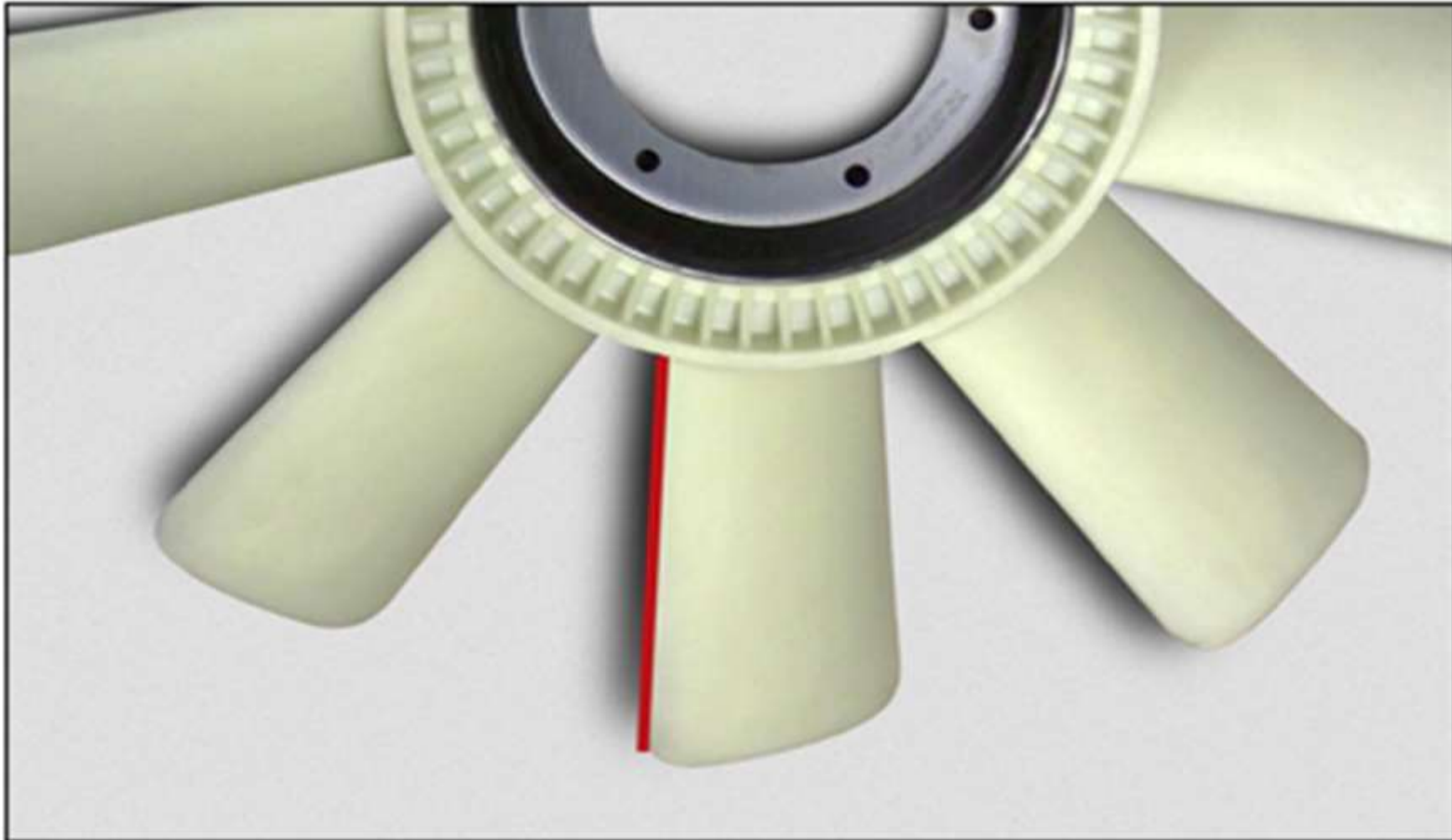

## BLOWER FAN

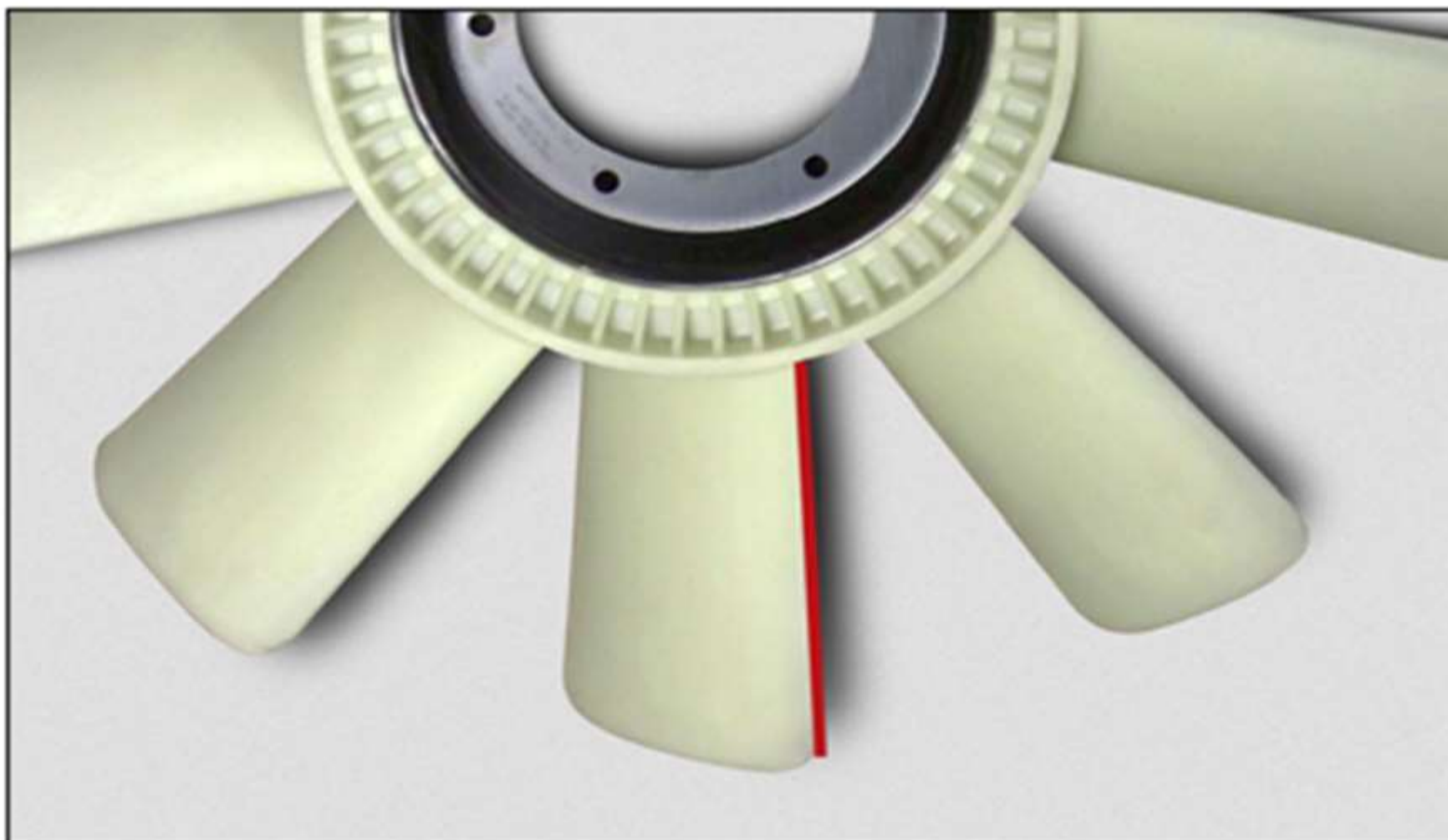

# HOW TO MEASURE

## TORQUE ARM

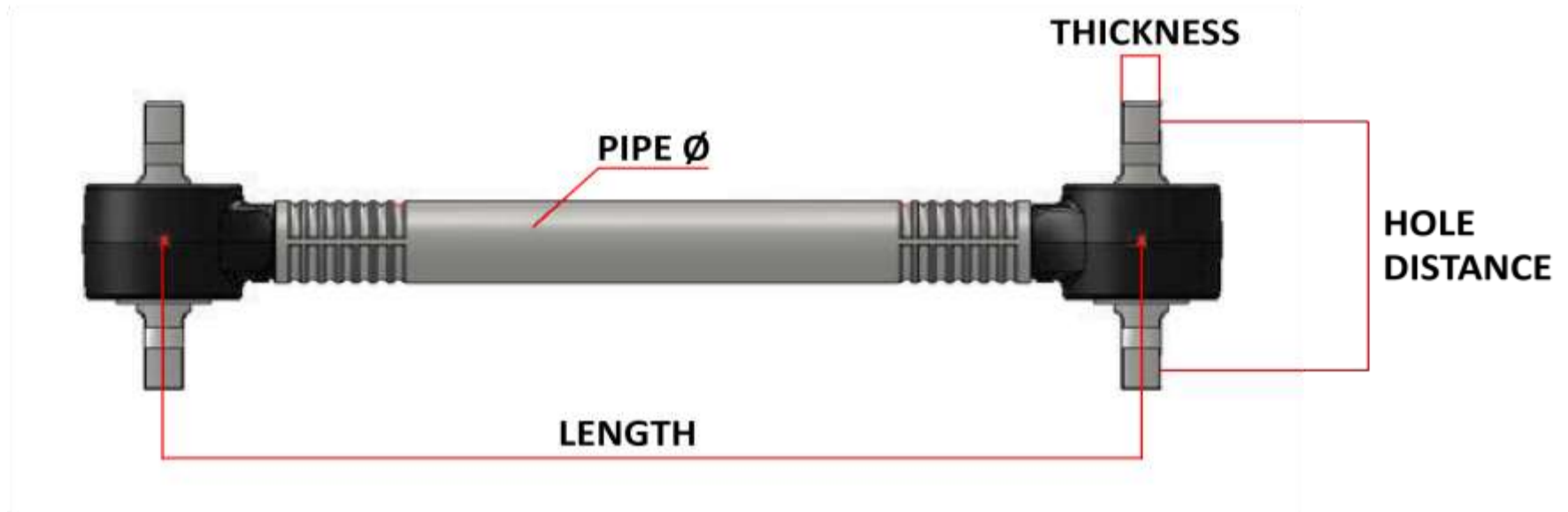

## DRAGLINK / TIE ROD

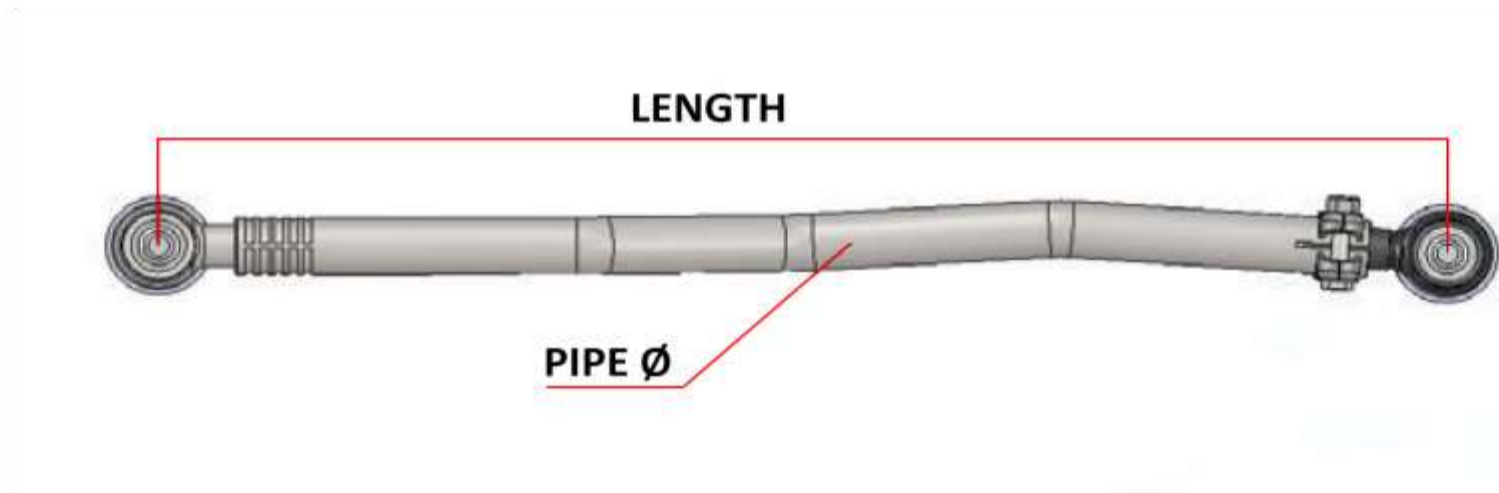

## TIE ROD END

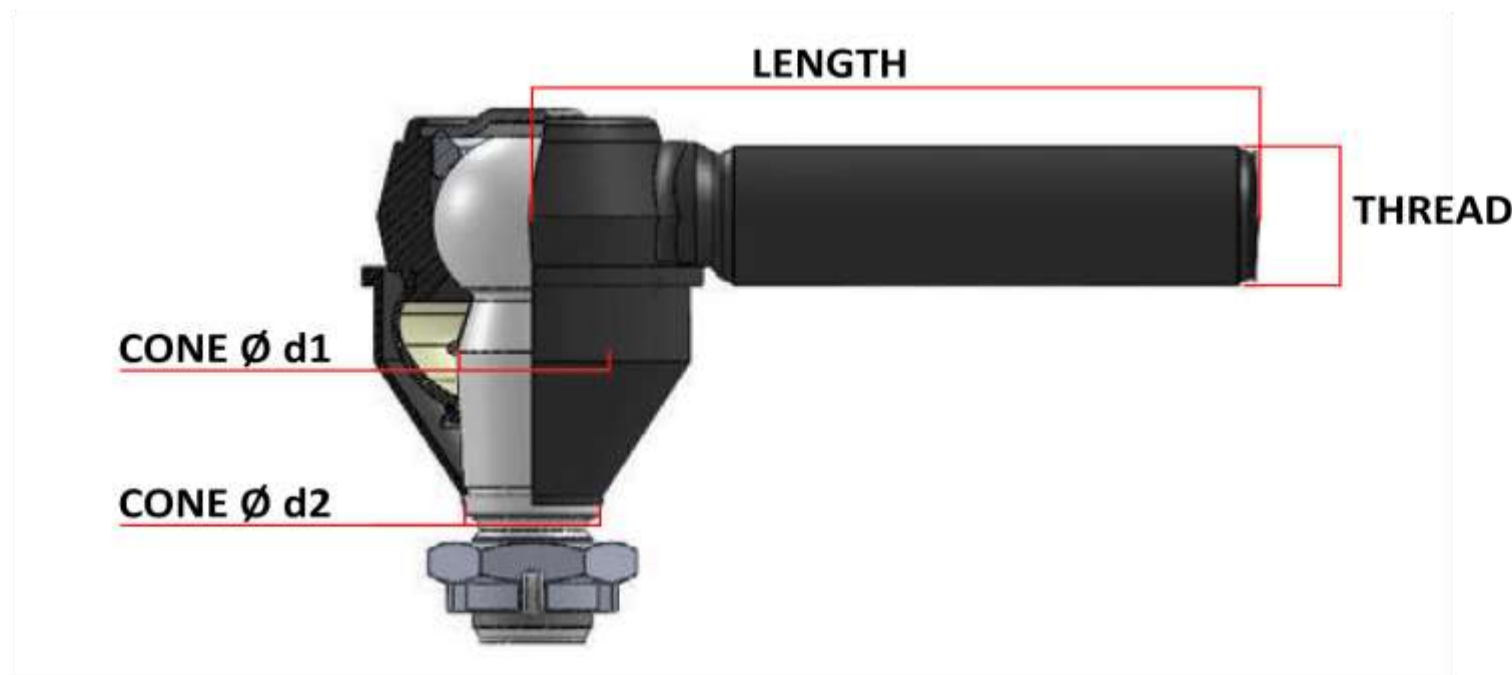

# HOW TO MEASURE

## TORQUE ARM / V-STAY BUSH

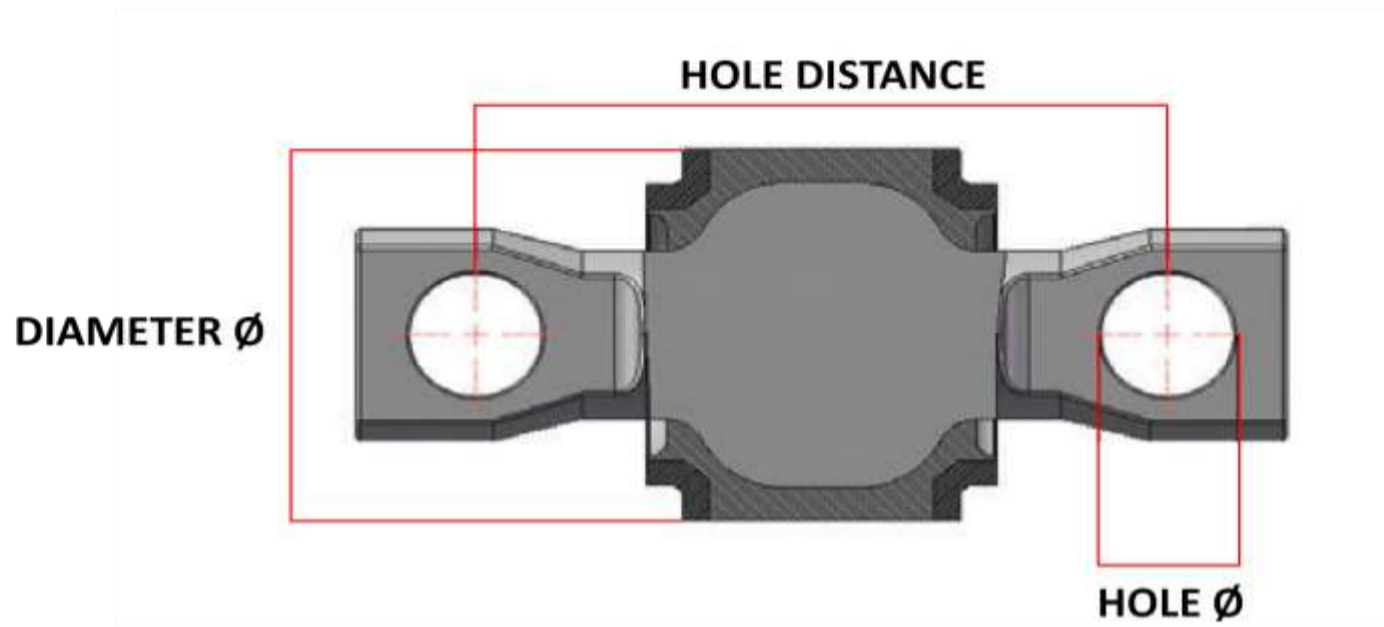

## V-STAY

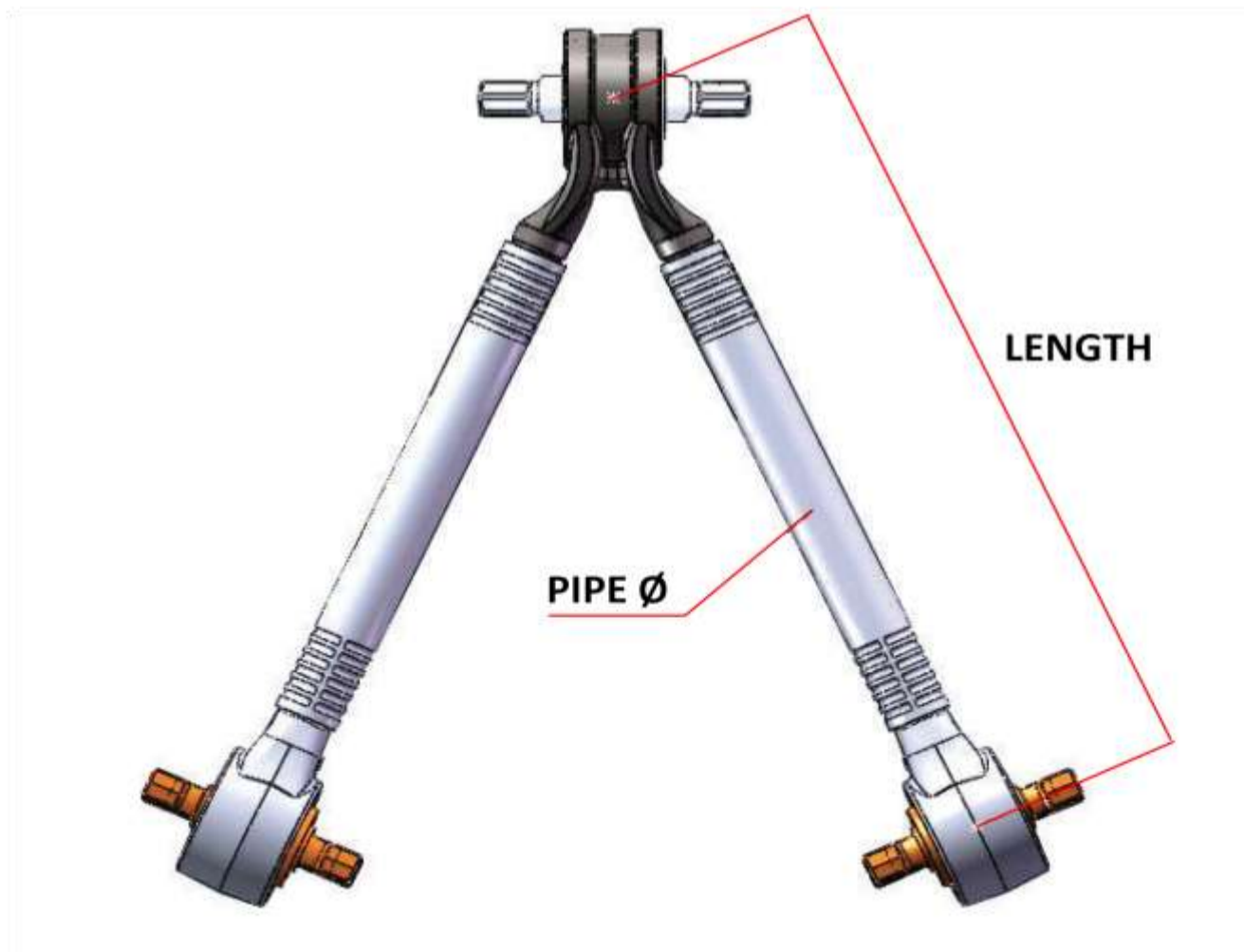











# AMERICAN GROUP



## INDEX

<u>GROUP</u>		<u>PAGES</u>
COOLING GROUP	9	12
ENGINE & TRANSMISSION GROUP	12	13
SUSPENSION GROUP	13	22
CLUTCH & BRAKE GROUP	22	22

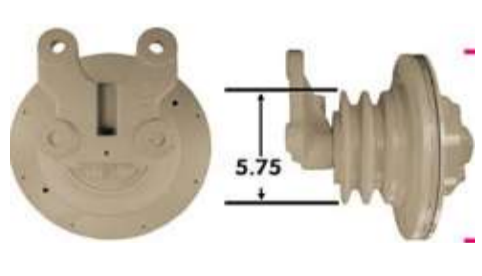

TC CODE	DESCRIPTION	GROUP	MAKE	MODEL	OE REFERENCE	REMARK	PICTURE
TF017	BORGWARNER FAN	COOLING	AMERICAN	FREIGHTLINER, INTERNATIONAL, CUMMINS	3507486C1	OD=765mm ID=65mm PCD=89mm 6 Holes	
TF018	BORGWARNER FAN	COOLING	AMERICAN	FREIGHTLINER, INTERNATIONAL, CUMMINS	2000729C2	OD=765mm ID=127mm PCD=152mm 6 Holes	
TF019	BORGWARNER FAN	COOLING	AMERICAN	FREIGHTLINER, INTERNATIONAL, CUMMINS	NA	OD=813mm ID=65mm PCD=89mm 6 Holes	
TF021	BORGWARNER FAN	COOLING	AMERICAN	CUMMINS	NA	OD=605mm ID=25mm PCD=60mm PCD=50mm 4 Holes	
TGT001	GOLDTOP	COOLING	AMERICAN	Freightliner, International, Mack, Caterpillar, Cummins, Detroit Diesel	994347, 994900, 994985, 995530, 995534, 995567, 995575, Gold-Top	<b>Fan Side:</b> PCD=89mm ID=65mm 6 Holes	
TGT021	2 SPEED GOLDTOP	COOLING	AMERICAN	Freightliner, International, Mack, Caterpillar, Cummins, Detroit Diesel	994636, 995509, 995510, 995519, 995557, 995582, 995617, Gold Top	<b>Fan Side:</b> PCD=89mm ID=65mm 6 Holes  <b>2 Speed</b>	
TGT003	9500HP KIT	COOLING	AMERICAN	Freightliner, International, Mack, Caterpillar, Cummins, Detroit Diesel	601158, 894305, 994305, 994322, 994336, 994388, 994389	<b>Fan Side:</b> PCD=152mm ID=127mm 6 Holes	
TGT005	BORGWARNER FAN HUB	COOLING	AMERICAN	Freightliner NTC, Kenworth NTC, N14, Mack NT88, Navistar 315, N14, NT88, NTC, Western Star NTC, N14	981102, 981116, 981128, 981198, 981252, 981260, 981369, 991001, 991015	Use Kit: <b>9500HP</b>	
TGT006	BORGWARNER FAN HUB	COOLING	AMERICAN	Freightliner N14, NTC, Navistar NTC, Kenworth N14, NTC	791016, 849813, 981012, 981085, 981169, 981186, 981273, 991015, 991044	Use Kit: <b>9500HP</b>	
TGT007	BORGWARNER FAN HUB	COOLING	AMERICAN	Navistar N14	1674030c91, 591019, 791019, 791123, 981028, 981155, 981239, 991044, 991150	Use Kit: <b>9500HP</b>	

TC CODE	DESCRIPTION	GROUP	MAKE	MODEL	OE REFERENCE	REMARK	PICTURE
TGT008	BORGWARNER FAN HUB	COOLING	AMERICAN	Freightliner Series 60, Kenworth Series 60, Sterling Series 60, Volvo Series 60	981143, 981146, 981147, 981176, 981224, 981324, 981342, 991064, 981143	Use Kit: 9500HP	
TGT009	BORGWARNER FAN HUB	COOLING	AMERICAN	Freightliner ISX	791086, 981389, 991398	Use Kit: 9500HP	
TGT010	BORGWARNER FAN HUB	COOLING	AMERICAN	Peterbilt N14	791100, 981212, 991204	Use Kit: 9500HP	
TGT011	BORGWARNER FAN HUB	COOLING	AMERICAN	Freightliner Series 60	79A9064, 989064, 98A9064, 999064, 99A9064	Use Kit: Goldtop	
TGT012	BORGWARNER FAN HUB	COOLING	AMERICAN	Freightliner ISX	20822-3541, 989088, 999088	Use Kit: Goldtop	
TGT013	BORGWARNER FAN HUB	COOLING	AMERICAN	Peterbilt ISX	05-25159-016, 79A9101, 989101, 999101	Use Kit: Goldtop	
TGT014	BORGWARNER FAN HUB	COOLING	AMERICAN	International ISX	3601420c92, 799324, 79A9324, 989324, 98A9324, 999324, 99A9324	Use Kit: Goldtop	
TGT015	BORGWARNER FAN HUB	COOLING	AMERICAN	Freightliner ISX	799052, 79A9512, 989052, 989512, 98A9512, 999052, 999512, 99A9512	Use Kit: Goldtop	
TGT016	BORGWARNER FAN HUB	COOLING	AMERICAN	Freightliner 3406	799074, 79a9074, 989074, 98A9074, 999074, 99A9074	Use Kit: Goldtop	
TGT017	BORGWARNER FAN HUB	COOLING	AMERICAN	Freightliner C10, C12	799070, 799292, 79a9292, 989070, 989292, 98A9292, 999070, 999292, 98A9292	Use Kit: Goldtop	

TC CODE	DESCRIPTION	GROUP	MAKE	MODEL	OE REFERENCE	REMARK	PICTURE
TGT018	BORGWARNER FAN HUB	COOLING	AMERICAN	Kenworth ISX, Peterbilt ISX	05-11369-074, 3681244, 791080, 987043, 987081, 997053, 997091	Use Kit: 9500HP	
TGT002	REPAIR KIT	COOLING	AMERICAN	FREIGHTLINER, INTERNATIONAL	85102233, 994346		
THK000	KYSOR BORGWARNER FAN HUB	COOLING	AMERICAN	KYSOR	1090-05262-01, 1090-06060-02, 1090-06060-03, 1090-06620-01, 1090-07050-01, 1090-08000-01, 1090-09000-01, 1616955c	Front Air	
THK001	KYSOR BORGWARNER FAN HUB	COOLING	AMERICAN	KYSOR	1090-09500-01, 1090-09500-01B, 1090-09650-01, 1090-09650-01B, 2514343C91, 85134489	Rear Air	
THK002	KYSOR BORGWARNER FAN HUB	COOLING	AMERICAN	KYSOR	1077-07899-01, 1093-07900-01, 2022293C91, 2501021C91, 3099313	2 Pulley	
THK003	KYSOR BORGWARNER FAN HUB	COOLING	AMERICAN	KYSOR	1093-09173-01, 1293-09173-01, 2602017C1, 3544849C91, 43759	Fine Groove Pulley	
THK014	KYSOR BORGWARNER FAN HUB	COOLING	AMERICAN	KYSOR	1077-07905-02, 1093-07906-02, 1093-07906-03, 2025898C91, 2501020C91, 3510192C91, 3534857C91, 4024693	Fine Groove Pulley	
THK004	KYSOR REPAIR KIT	COOLING	AMERICAN	KYSOR	1033-05435-02, 1681030c92, 9908401	Front Air	
THK007	KYSOR REPAIR KIT	COOLING	AMERICAN	KYSOR	1033-07781-01, 1695793C91, 9908300	Bearing Kit	
THK008	KYSOR REPAIR KIT	COOLING	AMERICAN	KYSOR	1033-09339-01, 1033-40600-02, 2509688C91	Rear Air	











TC CODE	DESCRIPTION	GROUP	MAKE	MODEL	OE REFERENCE	REMARK	PICTURE
THK009	KYSOR REPAIR KIT	COOLING	AMERICAN	KYSOR	1033-09339-04	Front Air	
THK010	KYSOR REPAIR KIT	COOLING	AMERICAN	KYSOR	1033-09340-01, 1033-40600-01, 9908407	Lining Kit	
THK012	KYSOR REPAIR KIT	COOLING	AMERICAN	KYSOR	NA	Bearing Kit	
THK3207	KYSOR REPAIR KIT	COOLING	AMERICAN	KYSOR	NA	Bearing Kit	
THK016	KYSOR SOLENOID	COOLING	AMERICAN	Freightliner, International	1056-07994-01		
THH015	THERMAL SWITCH	COOLING	AMERICAN	Freightliner, International	1KS280, 983619, 993605		
TM230	MOUNTING	ENGINE & TRANSMISSION	AMERICAN	CUMMINS		OD=74/48mm ID=17mm H=56mm	
TM231	MOUNTING	ENGINE & TRANSMISSION	AMERICAN	CUMMINS		OD=74/60/38mm ID=16mm H=60mm	
TM232	MOUNTING	ENGINE & TRANSMISSION	AMERICAN				
TM234	MOUNTING	ENGINE & TRANSMISSION	AMERICAN	KENWORTH			

TC CODE	DESCRIPTION	GROUP	MAKE	MODEL	OE REFERENCE	REMARK	PICTURE
TM300	MOUNTING	ENGINE & TRANSMISSION	AMERICAN				
8828	BUSH	SUSPENSION	AMERICAN	FREIGHTLINER, PETERBILT, NAVISTAR, MACK, KENTHWORTH, HENDRICKSON	IPC936420, 227720, 1693061C1, 1686227720, 836940, 44695000L, 64400002L	OD=70mm PCD=111mm Hole ID=18mm	
TA013B/S/N	BUSH	SUSPENSION	AMERICAN	FREIGHTLINER, PETERBILT, NAVISTAR, MACK, KENTHWORTH, HENDRICKSON	169306101, 44695000, 1693061C1S, 1688227720S, 227720S1, 1688227720S	OD=69.85mm PCD=111mm Hole ID=16mm	
TA009B/NG	BUSH	SUSPENSION	AMERICAN	FREIGHTLINER	81897	OD=56mm PCD=111mm Hole ID=16mm	
15695	BUSH	SUSPENSION	AMERICAN	FREIGHTLINER	TS00-22500		
TA013B/TP	BUSH	SUSPENSION	AMERICAN	FREIGHTLINER, PETERBILT, NAVISTAR, KENTHWORTH, HENDRICKSON	IPC936230, 0229610, 1693066C1, 229610, 44697000L	OD=69.85mm L=203.2mm Taper L=76.2mm	
TA009B	BUSH	SUSPENSION	AMERICAN	FREIGHTLINER, PETERBILT, NAVISTAR, HENDRICKSON	47691000, 47691	OD=52mm PCD=111mm Hole ID=16mm	
15699	BUSH	SUSPENSION	AMERICAN	NAVISTAR, MACK, HENDRICKSON	1693064C1, 1688229240, 64400007L	OD=69.85mm L=177.8mm Taper L=47.63mm	
15652	BUSH	SUSPENSION	AMERICAN	HENDRICKSON	69210000	OD=50mm PCD=111mm Hole ID=19mm	
15523	BUSH	SUSPENSION	AMERICAN	HENDRICKSON	NS140059	OD=90mm ID=28.5mm H=73.5mm	

NAMES, NUMBERS, SYMBOLS, DESCRIPTIONS LISTED IN THIS DOCUMENT ARE USED FOR REFERENCE PURPOSE ONLY AND IT IS NOT IMPLIED THAT ANY PARTS LISTED IS THE PRODUCT OF THESE MANUFACTURERS.

TC CODE	DESCRIPTION	GROUP	MAKE	MODEL	OE REFERENCE	REMARK	PICTURE
TPB305 / 15524	BUSH	SUSPENSION	AMERICAN	HENDRICKSON	NS140179	OD=90mm PCD=135mm Hole ID=21mm	
15654	BUSH	SUSPENSION	AMERICAN	HENDRICKSON	49210000, 227723	OD=69.85mm PCD=111mm Hole ID=19mm	
TA012B/SX	BUSH	SUSPENSION	AMERICAN	FREIGHTLINER, INTERNATIONAL, HENDRICKSON	0305108	OD=74mm PCD=110mm	
TA012B/NG/SX	BUSH	SUSPENSION	AMERICAN	PETERBILT, KENWORTH	656002	OD=66mm PCD=110mm	
TA012B/S/N	BUSH	SUSPENSION	AMERICAN	FREIGHTLINER, INTERNATIONAL, HENDRICKSON	1693061C1, 484680C1, 44695, 44695-000L	OD=65mm PCD=110mm	
TA013B/NP/SX	BUSH	SUSPENSION	AMERICAN	FREIGHTLINER	1615632000	OD=79mm PCD=110mm	
15606	TORQUE ARM	SUSPENSION	AMERICAN	FREIGHTLINER, HENDRICKSON	161897200, 62045615N	L=615mm PCD=111mm  1=TA009B	
15684	TORQUE ARM	SUSPENSION	AMERICAN	FREIGHTLINER, NAVISTAR, MACK, KENTHORTH, HENDRICKSON	6813262065, 1661925C91, 25164946, 944270, 62000610	L=610mm PCD=111mm  Sealed Bushes	
15685	TORQUE ARM	SUSPENSION	AMERICAN	FREIGHTLINER, NAVISTAR	IPC927180, 1610420000, 3581271C2	L=460mm PCD=111mm  1=TA009B	
15687	TORQUE ARM	SUSPENSION	AMERICAN	FREIGHTLINER	1610420001	L=462mm	

NAMES, NUMBERS, SYMBOLS, DECEPTIONS LISTED IN THIS DOCUMENT ARE USED FOR REFERENCE PURPOSE ONLY AND IT IS NOT IMPLIED THAT ANY PARTS LISTED IS THE PRODUCT OF THESE MANUFACTURERS.

TC CODE	DESCRIPTION	GROUP	MAKE	MODEL	OE REFERENCE	REMARK	PICTURE
15688	TORQUE ARM	SUSPENSION	AMERICAN	FREIGHTLINER	1616749001, 6813266716	L=610mm	
15689	TORQUE ARM	SUSPENSION	AMERICAN	FREIGHTLINER	1616749000, 6813266316	L=584mm	
15690	TORQUE ARM	SUSPENSION	AMERICAN	FREIGHTLINER	1613053000	L=422mm	
15692	TORQUE ARM	SUSPENSION	AMERICAN	FREIGHTLINER	1615632001	L=610mm	
15696	TORQUE ARM	SUSPENSION	AMERICAN	FREIGHTLINER, PETERBILT, KENTHWORTH	C656009, C656002, C656009	L=650mm  Sealed Bushes	
15703	TORQUE ARM	SUSPENSION	AMERICAN	FREIGHTLINER	1615632000	L=615mm	
15711	TORQUE ARM	SUSPENSION	AMERICAN	FREIGHTLINER, NAVISTAR, HENDRICKSON	IPC928660, IPC928661, 1693536C1	L=775mm PCD=111mm  1=TA013B/S/N	
15719	TORQUE ARM	SUSPENSION	AMERICAN	FREIGHTLINER, NAVISTAR, MACK, HENDRICKSON	HDR62000565, HDR62001565, HD62000565, 17QF460P223, 67428565	L=565mm PCD=111mm  1=TA009B	
TA013A/TP	TORQUE ARM	SUSPENSION	AMERICAN	FREIGHTLINER, KENTHWORTH, HENDRICKSON	6813267016, 925150, 62350635	L=642mm  1=TA013B/S/N 2=TA013B/TP	
15680	TORQUE ARM	SUSPENSION	AMERICAN	PETERBILT	0304119, 924170	L=441mm PCD=111mm  1=TA013B/S/N	









NAMES, NUMBERS, SYMBOLS, DECEPTIONS LISTED IN THIS DOCUMENT ARE USED FOR REFERENCE PURPOSE ONLY AND IT IS NOT IMPLIED THAT ANY PARTS LISTED IS THE PRODUCT OF THESE MANUFACTURERS.

TC CODE	DESCRIPTION	GROUP	MAKE	MODEL	OE REFERENCE	REMARK	PICTURE
15681	TORQUE ARM	SUSPENSION	AMERICAN	PETERBILT	0304059, 0302439	L=582mm PCD=111mm  1=TA013B/S/N	
15682	TORQUE ARM	SUSPENSION	AMERICAN	PETERBILT	0304839	L=489mm PCD=111mm  1=TA013B/S/N	
15683	TORQUE ARM	SUSPENSION	AMERICAN	PETERBILT	SS32611	L=440mm  Sealed Bushes	
15697	TORQUE ARM	SUSPENSION	AMERICAN	PETERBILT	0304327	L=440mm PCD=111mm  1=TA013B/S/N	
15710	TORQUE ARM	SUSPENSION	AMERICAN	PETERBILT	943711, 0305108	L=655mm PCD=111mm  Sealed Bushes	
15686	TORQUE ARM	SUSPENSION	AMERICAN	NAVISTAR	493921C1, 588118C91	L=558mm PCD=111mm  1=TA013B/S/N	
15694	TORQUE ARM	SUSPENSION	AMERICAN	NAVISTAR	3580088C1,	L=644mm PCD=111mm  Sealed Bushes	
15698	TORQUE ARM	SUSPENSION	AMERICAN	NAVISTAR	3548381C1S, 3548381C1	L=644mm PCD=111mm  Sealed Bushes	
15727	TORQUE ARM	SUSPENSION	AMERICAN	NAVISTAR, MACK, KENTHWORTH, WESTERN STAR	3581270C1, 3581270C1S, 25164994, 17QF455P240, 925031, 358013441, 358013441S	L=610mm  1=TA013B/S/N 2=TA013B/TP	
15729	TORQUE ARM	SUSPENSION	AMERICAN	NAVISTAR	493920C3	L=460mm PCD=111mm  1=TA013B/S/N	



TC CODE	DESCRIPTION	GROUP	MAKE	MODEL	OE REFERENCE	REMARK	PICTURE
15678	TORQUE ARM	SUSPENSION	AMERICAN	MACK	30SQ4525		
15679	TORQUE ARM	SUSPENSION	AMERICAN	MACK, HENDRICKSON	8180645, 17QF357M1, 48411006	L=366mm PCD=111mm  1=TA009B	
15702	TORQUE ARM	SUSPENSION	AMERICAN	MACK	25162529, 17QF463P180	L=460mm  Sealed Bushes	
15704	TORQUE ARM	SUSPENSION	AMERICAN	MACK	17QF463P195, 17QF464P195	L=495mm  Sealed Bushes	
15705	TORQUE ARM	SUSPENSION	AMERICAN	MACK	17QF460P218, 25164942	L=554mm PCD=111mm  Seald Bushes	
15707	TORQUE ARM	SUSPENSION	AMERICAN	MACK	17QF463P228	L=578mm  Sealed Bushes	
15708	TORQUE ARM	SUSPENSION	AMERICAN	MACK	17QF463P243	L=616mm  Sealed Bushes	
15709	TORQUE ARM	SUSPENSION	AMERICAN	MACK, HENDRICKSON	25166077, 17QF460P200, 3226713	L=508mm PCD=111mm  1=TA013B/S/N	
15720	TORQUE ARM	SUSPENSION	AMERICAN	MACK, HENDRICKSON	25174706, 17QF460P220, 57857006	L=558.8mm PCD=111mm  Sealed Bushes	
15721	TORQUE ARM	SUSPENSION	AMERICAN	MACK, HENDRICKSON	25170833, 17QF473M4, 62000615	L=617mm PCD111mm  Sealed Bushes	

NAMES, NUMBERS, SYMBOLS, DECEPTIONS LISTED IN THIS DOCUMENT ARE USED FOR REFERENCE PURPOSE ONLY AND IT IS NOT IMPLIED THAT ANY PARTS LISTED IS THE PRODUCT OF THESE MANUFACTURERS.

TC CODE	DESCRIPTION	GROUP	MAKE	MODEL	OE REFERENCE	REMARK	PICTURE
15510	TORQUE ARM	SUSPENSION	AMERICAN	MACK, HENDRICKSON	20486749, 22936141, 3227111MUP	L=567mm PCD=111mm  1=TA009B/NG	1  1
15723	TORQUE ARM	SUSPENSION	AMERICAN	KENTHWORTH	K195474, K195472	L=504mm PCD=111mm  1=8828	1  1
15724	TORQUE ARM	SUSPENSION	AMERICAN	KENTHWORTH	K195474S, K195472S	L=508mm PCD=111mm  1=8828	1  1
15730	TORQUE ARM	SUSPENSION	AMERICAN	KENTHWORTH	C651008, C651009	L=515mm PCD=111mm  1=8828	1  1
15534	TORQUE ARM	SUSPENSION	AMERICAN	HENDRICKSON	58745008	L=640mm PCD=111mm  Sealed Bushes	
15691	TORQUE ARM	SUSPENSION	AMERICAN	HENDRICKSON	58757006	L=559mm PCD=111mm  1=TA009B	1  1
1349	V-STAY	SUSPENSION	AMERICAN	HENDRICKSON	381002, NS140270-43	L=700mm PCD=135/135mm Hole ID=21/21mm H=650mm  1=15523 2=15524	2  1
15525	V-STAY	SUSPENSION	AMERICAN	HENDRICKSON	HS381002, AMHS381002	L=650mm PCD=135/135mm Hole ID=21/21mm H=550mm  1=15523 2=15524	2  1
15562	V-STAY	SUSPENSION	AMERICAN	HENDRICKSON	AMNS14027042, NS14027042	L=600mm PCD=135/135mm Hole ID=21/21mm H=540mm  1=15523 2=15524	2  1
15563	V-STAY	SUSPENSION	AMERICAN	HENDRICKSON	AMNS140317, NS140317	L=630mm PCD=135/135mm Hole ID=21/21mm H=580mm  1=15523 2=15524	2  1

NAMES, NUMBERS, SYMBOLS, DECEPTIONS LISTED IN THIS DOCUMENT ARE USED FOR REFERENCE PURPOSE ONLY AND IT IS NOT IMPLIED THAT ANY PARTS LISTED IS THE PRODUCT OF THESE MANUFACTURERS.









TC CODE	DESCRIPTION	GROUP	MAKE	MODEL	OE REFERENCE	REMARK	PICTURE
9181	REPAIR KIT	SUSPENSION	AMERICAN	HENDRICKSON	3401373, 34013073	OD=111mm ID=63.5mm H=146mm	
9182	REPAIR KIT	SUSPENSION	AMERICAN	HENDRICKSON	21140034L, 21140034		
12967	REPAIR KIT	SUSPENSION	AMERICAN	HENDRICKSON	4588	OD=152mm ID=31.5mm H=171mm	
15647	REPAIR KIT	SUSPENSION	AMERICAN	HENDRICKSON	2963, S24681, S24112		
15650	REPAIR KIT	SUSPENSION	AMERICAN	HENDRICKSON	2202, 102202		
15655	REPAIR KIT	SUSPENSION	AMERICAN	HENDRICKSON	1117653B001, 34013088		
15656	REPAIR KIT	SUSPENSION	AMERICAN	HENDRICKSON	C21166, S24691		
15659	REPAIR KIT	SUSPENSION	AMERICAN	HENDRICKSON	34013049	OD=111mm OD=63.5mm H=146mm	
15660	REPAIR KIT	SUSPENSION	AMERICAN	HENDRICKSON	34013051	OD=111mm ID=63.5mm H=152.4mm	
15662	REPAIR KIT	SUSPENSION	AMERICAN	HENDRICKSON	S23320, S26321	OD=160mm ID=32mm H=92mm	

NAMES, NUMBERS, SYMBOLS, DECEPTIONS LISTED IN THIS DOCUMENT ARE USED FOR REFERENCE PURPOSE ONLY AND IT IS NOT IMPLIED THAT ANY PARTS LISTED IS THE PRODUCT OF THESE MANUFACTURERS.

TC CODE	DESCRIPTION	GROUP	MAKE	MODEL	OE REFERENCE	REMARK	PICTURE
TA020B	BUSH	SUSPENSION	NEW WAY	SUSPENSION			
TA021B	BUSH	SUSPENSION	NEW WAY	SUSPENSION	48100335	OD=98mm ID=64mm H=134mm	
TA023B	BUSH	SUSPENSION	NEW WAY	SUSPENSION	48100315	OD=98mm PCD=216mm Hole ID=25mm	
15649	SPACER RING	SUSPENSION	AMERICAN	NAVISTAR	258892C91	OD=178mm ID=84mm	
10906	SPACER RING	SUSPENSION	AMERICAN	HENDRICKSON	B116134	OD=180mm ID=60mm H=5mm	
12970	DISTANCE WASHER	SUSPENSION	AMERICAN	HENDRICKSON	S20924, C20924	OD=101mm ID=23mm H=38mm	
12971	DISTANCE WASHER	SUSPENSION	AMERICAN	HENDRICKSON	S20925, C20925	OD=101mm ID=23mm H=38mm	
15648	METAL WASHER	SUSPENSION	AMERICAN	HENDRICKSON	B21099, S21099	OD=178mm ID=84mm H=8.9mm	
15649	SPACER RING	SUSPENSION	AMERICAN	HENDRICKSON	B11613, S11613	OD=178mm ID=84mm H=27.5mm	
SEMTA064B	SPRING BUSH	SUSPENSION	AMERICAN	FREIGHTLINER, PETERBILT, NAVISTAR, KENTWORTH, HENDRICKSON	1616412000, 1616412001, 52296, 3538115C1, 52296, 51209	OD=64mm Hole ID=20mm PCD=145mm	

TC CODE	DESCRIPTION	GROUP	MAKE	MODEL	OE REFERENCE	REMARK	PICTURE
10211	SPRING BUSH	SUSPENSION	AMERICAN	FREIGHTLINER, NAVISTAR, MACK	WCM11223, HLD90008149, 2507718C1, 546211223	OD=70mm ID=30mm H=127mm	
8628	SPRING BUSH	SUSPENSION	AMERICAN	NAVISTAR, HENDRICKSON	124892R1, 441302C92, 45900000	OD=111mm ID=63.5mm H=146mm	
MBTM9402	RUBBER BUFFER	SUSPENSION	AMERICAN	HENDRICKSON	C3558, S21824	OD=152mm ID=31.5mm H=171mm	
HENTA7147B	SPRING BUSH	SUSPENSION	AMERICAN	HENDRICKSON	45507147	OD=60mm PCD=132mm Hole ID=18mm	
10447	RUBBER BUFFER	SUSPENSION	AMERICAN	HENDRICKSON	D22845, D25364	OD=160mm ID=32mm H=95mm	
10880	SPRING BUSH	SUSPENSION	AMERICAN	HENDRICKSON	HS509160	OD=62mm PCD=132mm Hole ID=18mm	
15651	SPRING BUSH	SUSPENSION	AMERICAN	HENDRICKSON	B28411, S28411	OD=86mm ID=32mm H=133mm	
9277	SPRING PIN	SUSPENSION	AMERICAN	MACK	10QK3105M, 10QK3106M	L=170mm OD=38mm M34x4	
13815	SPRING MOUNTING	SUSPENSION	AMERICAN	HENDRICKSON	NM1009, 49377000, 60879000	H=133mm PCD=175/143mm	
15664	SPRING MOUNTING	SUSPENSION	AMERICAN	HENDRICKSON	NM1010	H=152.4mm PCD=220/216mm	

NAMES, NUMBERS, SYMBOLS, DESCRIPTIONS LISTED IN THIS DOCUMENT ARE USED FOR REFERENCE PURPOSE ONLY AND IT IS NOT IMPLIED THAT ANY PARTS LISTED IS THE PRODUCT OF THESE MANUFACTURERS.

TC CODE	DESCRIPTION	GROUP	MAKE	MODEL	OE REFERENCE	REMARK	PICTURE
15668	STABILIZER BUSH	SUSPENSION	AMERICAN	FREIGHTLINER, KENTHWORTH	1614603000, 53231	OD=63.5mm L=174.5mm	
15672	STABILIZER BUSH	SUSPENSION	AMERICAN	FREIGHTLINER	651001	OD=44.7mm L=179mm	
15675	STABILIZER REPAIR KIT	SUSPENSION	AMERICAN	FREIGHTLINER, PETERBILT, NAVISTAR, MACK	HDRK069731, RK069731, SAFRK069731, 3889RK369731		
108391-74AM	EATON CLUTCH	CLUTCH & BRAKE	AMERICAN	FREIGHTLINER, INTERNATIONAL	108391-74AM	15 1/2" x 2" HD2.00 EP1552 <b>TWIN PLATE</b>	
108925-82Z	EATON CLUTCH	CLUTCH & BRAKE	AMERICAN	FREIGHTLINER, INTERNATIONAL	108925-82Z	15 1/2" x 2" DCF (7) [4] <b>EASY PEDAL</b>	
122003-42A	EATON CLUTCH	CLUTCH & BRAKE	AMERICAN	FREIGHTLINER, INTERNATIONAL	122003-42A	ECA with LCIB	
209701-25L	EATON CLUTCH	CLUTCH & BRAKE	AMERICAN	FREIGHTLINER, INTERNATIONAL	209701-25L	15 1/2" x 2" DCF-CO-VCT <b>SOLO HI-TORQUE</b>	
209701-82	EATON CLUTCH	CLUTCH & BRAKE	AMERICAN	FREIGHTLINER, INTERNATIONAL	209701-82	15 1/2" x 2" DCF-CO <b>SOLO LOW-TORQUE</b>	
K-4094	CLUTCH REPLACEMENT MOUNT CLUTCH KIT	CLUTCH & BRAKE	AMERICAN	FREIGHTLINER, INTERNATIONAL	10405624		

# BELL GROUP



## INDEX

<u>GROUP</u>		<u>PAGES</u>
COOLING GROUP	24	24
SUSPENSION GROUP	24	25

TC CODE	DESCRIPTION	GROUP	MAKE	MODEL	OE REFERENCE	REMARK	PICTURE
TVF023	BORGWARNER FAN	COOLING	BELL	366 Ti	9062050406	OD=704mm PCD=152mm ID=127mm 6 Holes	
TVF023FM	FAN MARKET FAN	COOLING	BELL	366 Ti	9062050406	OD=704mm PCD=152mm ID=127mm 6 Holes	
MBTVF13027	FAN	COOLING	BELL	B40	0032054206	OD=750mm PCD=200mm ID=180mm 6 Holes	
TVD022	BORGWARNER VISCOUS	COOLING	BELL	B25	221390	<b>Fan Side:</b> ID=127mm PCD=152mm 6 Holes <b>Engine Side:</b> PCD=64mm 4 Holes	
TVD022FM	BORGWARNER VISCOUS	COOLING	BELL	B25	221390	<b>Fan Side:</b> ID=127mm PCD=152mm 6 Holes <b>Engine Side:</b> PCD=64mm 4 Holes	
TVD028	BORGWARNER VISCOUS	COOLING	BELL	B40, B50	0002008422	<b>Fan Side:</b> ID=180mm PCD=200mm 6 Holes <b>Engine Side:</b> PCD=140mm 3 Holes	
TVD028FM	FAN MARKET VISCOUS	COOLING	BELL	B40, B50	0002008422	<b>Fan Side:</b> ID=180mm PCD=200mm 6 Holes <b>Engine Side:</b> PCD=140mm 3 Holes	
TA050B	BUSH	SUSPENSION	BELL	B25D	206536, 200180, 201180	OD=90mm	
TA058B	BUSH	SUSPENSION	BELL	B25D, B30D, B40D	203739	OD=Ø108mm Hole ID=21mm PCD=152mm	
TPM2013/10	SPRING MOUNTING	SUSPENSION	BELL	B40	206980		





TC CODE	DESCRIPTION	GROUP	MAKE	MODEL	OE REFERENCE	REMARK	PICTURE
TSM005	SPRING MOUNTING	SUSPENSION	BELL	B25	216482		

# BMC GROUP



## INDEX

<u>GROUP</u>		<u>PAGES</u>
ENGINE & TRANSMISSION GROUP	27	27
SUSPENSION GROUP	27	27
CLUTCH & BRAKE GROUP	27	27

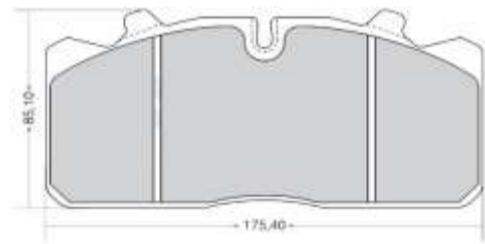



TC CODE	DESCRIPTION	GROUP	MAKE	MODEL	OE REFERENCE	REMARK	PICTURE
BMCTM3109	MOUNTING	ENGINE & TRANSMISSION	BMC	MEGASTAR	51RS203109	H=47,5mm M12x1,25  <b>Left</b>	
BMCTM3110	MOUNTING	ENGINE & TRANSMISSION	BMC	MEGASTAR	51RS203110	H=47,5mm M12x1,25  <b>Right</b>	
BMCTA7683B	BUSH	SUSPENSION	BMC	BMC	NA	OD=67mm Hole ID=20mm PCD=111,25mm	
D565	EREN BRAKE PAD	CLUTCH & BRAKE	BMC	PROBUS	WVA: 29088	Length=175.4mm Width=84.1mm Thickness=25mm  <b>Front &amp; Rear</b>	

# BOMAG GROUP



## INDEX

<u>GROUP</u>		<u>PAGES</u>
ENGINE & TRANSMISSION GROUP	29	29

TC CODE	DESCRIPTION	GROUP	MAKE	MODEL	OE REFERENCE	REMARK	PICTURE
TC001	MOUNTING	ENGINE & TRANSMISSION	BOMAG	BW161, BW212, BW213, BW214	06119395		
TC002	MOUNTING	ENGINE & TRANSMISSION	BOMAG	BW216, BW217, BW219	06180112	H=79mm L=30mm W=100mm	
TM901	MOUNTING	ENGINE & TRANSMISSION	BOMAG	BW211, BW212 BW213, BW214 BW216, BW219, BW225 BW216, BW219 BW225	06180100	PCD=295/85mm H=96mm	
TM903/16	MOUNTING	ENGINE & TRANSMISSION	BOMAG	BW211, BW212 BW213, BW214 BW216, BW219, BW225 BW156, BW177 BW178, BW179	06129901		
TM903/20	MOUNTING	ENGINE & TRANSMISSION	BOMAG	BW - SERIES	NA		

# CATERPILLAR GROUP



## INDEX

<u>GROUP</u>		<u>PAGES</u>
COOLING GROUP	31	31
ENGINE & TRANSMISSION GROUP	31	31
SUSPENSION GROUP	31	31

TC CODE	DESCRIPTION	GROUP	MAKE	MODEL	OE REFERENCE	REMARK	PICTURE
TF027	BORGLWARNER FAN	COOLING	CATERPILLAR			OD=560mm ID=41mm PCD=63mm 4 Holes	
CATTVD3589	BORGLWARNER VISCOUS	COOLING	CATERPILLAR	325D, C7 DIESEL	281-3589	<b>Fan Side:</b> ID=177mm PCD=214mm 6 Holes <b>Engine Side:</b> PCD=89mm 6 Holes	
TC003	MOUNTING	ENGINE & TRANSMISSION	CATERPILLAR	D10N, D10R, D9L	7G2703	H=122/54mm L=374mm W=211mm	
TC003A	MOUNTING	ENGINE & TRANSMISSION	CATERPILLAR	D10N, D10R, D9L	7G2704	H=114/54mm L=374mm W=211mm	
TPB100	BUSH	SUSPENSION	CATERPILLAR	740, D350E	3518204	OD=105mm PCD=152mm Hole ID=25	
TPB2012/3	BUSH	SUSPENSION	CATERPILLAR	735, 740, D350E	1647826	OD=104mm PCD=152mm Hole ID=25	
TPB305	BUSH	SUSPENSION	CATERPILLAR	725, 730, D250E, D300E	1485563	OD=90mm PCD=130mm Hole ID=19mm	
TC004E	SPRING MOUNTING	SUSPENSION	CATERPILLAR	735, 740, D350E, D400E	2114987, 1389224		

# DAF GROUP



## INDEX

<u>GROUP</u>		<u>PAGES</u>
COOLING GROUP	33	33
ENGINE & TRANSMISSION GROUP	33	34
STEERING GROUP	34	35
SUSPENSION GROUP	35	36
CAB GROUP	36	36
CLUTCH & BRAKE GROUP	36	37





TC CODE	DESCRIPTION	GROUP	MAKE	MODEL	OE REFERENCE	REMARK	PICTURE
TVF027	FAN	COOLING	DAF	95XF, CF75, CF85, XF105	1291218, 1315854	OD=750mm PCD=200mm ID=180mm 6 Holes	
TVF023	BORGWARNER FAN	COOLING	DAF	95XF, CF75, CF85, XF105	1448197, 1236096	OD=704mm PCD=152mm ID=127mm 6 Holes	
TVD105	BORGWARNER VISCOUS	COOLING	DAF	95XF	1436105	<b>Fan Side:</b> ID=127mm PCD=152mm 6 Holes <b>Engine Side:</b> PCD=130mm 6 Holes	
TVD679	BORGWARNER VISCOUS	COOLING	DAF	CF75, CF85	1449679	<b>Fan Side:</b> ID=177mm PCD=214mm 6 Holes <b>Engine Side:</b> PCD= 6 Holes	
7PK-BELTS	V-BELT	ENGINE & TRANSMISSION	DAF	75CF, CF85		Range from: 7PK1753 Till: 7PK1824	
8PK-BELTS	V-BELT	ENGINE & TRANSMISSION	DAF	XF95, CF85, XF105, CF75, 75CF		Range from: 8PK1220 Till: 8PK2380	
9PK-BELTS	V-BELT	ENGINE & TRANSMISSION	DAF	XF95, XF105, 75CF, CF85		Range from: 9PK1380 Till: 9PK1424	
10PK-BELTS	V-BELT	ENGINE & TRANSMISSION	DAF	95XF		10PK1360	
YP033	BELT TENSIONER	ENGINE & TRANSMISSION	DAF	CF85, XF95	1628148, 1614978, 1458764		
YP041	BELT TENSIONER	ENGINE & TRANSMISSION	DAF	CF85, XF105	1695242, 1624953		

NAMES, NUMBERS, SYMBOLS, DESCRIPTIONS LISTED IN THIS DOCUMENT ARE USED FOR REFERENCE PURPOSE ONLY AND IT IS NOT IMPLIED THAT ANY PARTS LISTED IS THE PRODUCT OF THESE MANUFACTURERS.

TC CODE	DESCRIPTION	GROUP	MAKE	MODEL	OE REFERENCE	REMARK	PICTURE
YP082	BELT TENSIONER	ENGINE & TRANSMISSION	DAF	CF	1704635, 3976831, 3945527, 3957434, 5259022		
YP093	BELT TENSIONER	ENGINE & TRANSMISSION	DAF		5333480, 3978200, 3936210, 3934822, 3914854, 3910707		
YP097	BELT TENSIONER	ENGINE & TRANSMISSION	DAF	cf	4891116, 4987964, 1399691, 1406486		
DAFTS12906A	DRAGLINK	STEERING	DAF	CF65, CF75, CF85	1602821, 1363859, 1448063	Taper 1=27mm Taper 2=30mm Length=867mm  1=TS028 2=Crimped	
DAFTS14605	TIE ROD	STEERING	DAF	CF75, CF65, XF105	1732980	Taper 1=27mm Taper 2=30mm Length=1522mm  1=MTS11563B 2=Crimped	
TS026	TIE ROD END	STEERING	DAF	XF95, XF105, CF65, CF75, CF85, Bus	0586753, 0607999, 0698609, 0694298, 1229944, 0694360, 1331925, 1137230	Taper 1=23,5mm Taper 2=26mm M30  <b>Right Hand</b>	
TS027	TIE ROD END	STEERING	DAF	XF95, XF105, CF65, CF75, CF85, Bus	0311300, 1338714, 0607998, 1315447, 1319838, ACHF241, MAK1295	Taper 1=23,5mm Taper 2=26mm M30  <b>Left Hand</b>	
TS028	TIE ROD END	STEERING	DAF	XF95, XF105, CF65, CF75, CF85	0607981, 0698450, 1257890, 1603789, 1149907, 1618048, ACHF060	Taper 1=27mm Taper 2=30mm M30  <b>Right Hand</b>	
TS029	TIE ROD END	STEERING	DAF	XF95, XF105, CF65, CF75, CF85	0607053, 0696205, 1228115, 0696225, 1329134	Taper 1=27mm Taper 2=30mm M30  <b>Left Hand</b>	
TS11580B	TIE ROD END	STEERING	DAF	CF65, CF75	1389190	Taper 1=23,5mm Taper 2=26mm M30  <b>Right Hand</b>	

TC CODE	DESCRIPTION	GROUP	MAKE	MODEL	OE REFERENCE	REMARK	PICTURE
MTS11563B	TIE ROD END	STEERING	DAF	CF75, CF65, XF105	1785340	Taper 1=27mm Taper 2=30mm M30  <b>Right Hand</b>	
TS10931	GEAR SHIFT LINK	STEERING	DAF	CF65, CF85, Bus	0589333, 0656085, 1249129, 140362	Taper 1=10mm Taper 2=10mm M12  <b>Right Hand</b>	
TS10937	GEAR SHIFT LINK	STEERING	DAF	CF65, CF85, Bus	0592106, 0656084, 1249088, 140363	Taper 1=10mm Taper 2=10mm M12  <b>Left Hand</b>	
TS10943	GEAR SHIFT LINK	STEERING	DAF	XF95	542477	Taper 1=10,8mm Taper 2=12mm M14  <b>Right Hand</b>	
MTA7635B	BUSH	SUSPENSION	DAF	Bus	0067354	OD=75mm Hole ID=19mm PCD=130mm	
MBTA7431B	BUSH	SUSPENSION	DAF	CF65, F85, F95, XF105	0693778S, 693778S	OD=80mm Hole ID=21mm PCD=152mm	
TA001B	BUSH	SUSPENSION	DAF	F Series	0691703	OD=85mm Hole ID=21mm PCD=152mm	
VOLTA1187B	BUSH	SUSPENSION	DAF	FT, CF75, 85CF, CF85, XF95, XF105	689748, 0689748	OD=75mm Hole ID=17mm PCD=115mm	
TA005B	BUSH KIT	SUSPENSION	DAF	XF95, 105, CF65	0693778, 693778	OD=80mm H=24mm	
TA069B	BUSH KIT	SUSPENSION	DAF	XF95, 105	1271124	OD=72mm Hole ID=19mm PCD=130mm	

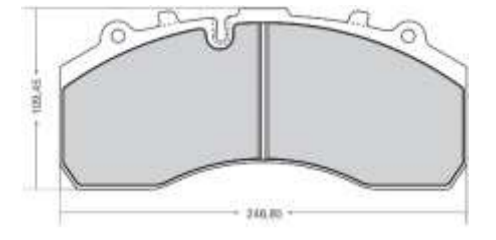
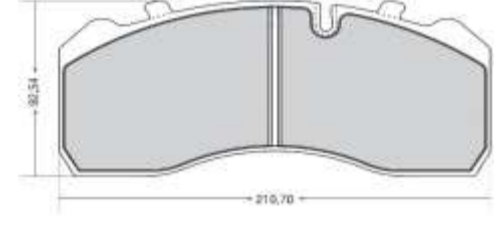
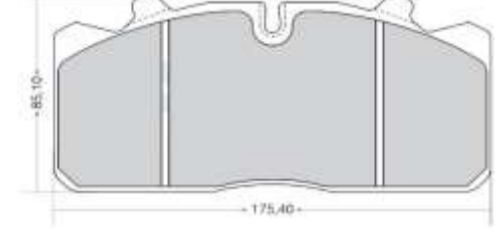
TC CODE	DESCRIPTION	GROUP	MAKE	MODEL	OE REFERENCE	REMARK	PICTURE
TA024B	BUSH KIT	SUSPENSION	DAF	CF75, CF85	0696320	D=90mm	
DAFTA0436A	V-STAY	SUSPENSION	DAF	DF75, 85, 75 CF	1620436, 1361652, 1793876	L=608mm Hole ID=23/23mm PCD=152/152mm  1=TA024B 2=TA001B	
DAFTA9819A	V-STAY	SUSPENSION	DAF	CF75, 85, 95XF	0649819, 1620437, 1793877	L=603mm Hole ID=23/23mm PCD=152/152mm  1=TA024B 2=TA003B	
DAFTA8755B	SPRING BUSH	SUSPENSION	DAF	CF65, CF75, XF95	1357764	OD=62,5mm ID=24mm H=86mm	
HENTA7147B	SPRING BUSH	SUSPENSION	DAF	XF95, 105, CF85	1681114	OD=60mm PCD=132mm Hole ID=18mm	
DAFFTA11281B	CAB REPAIR KIT	CAB	DAF	XF95, CF75, CF85	14251605 13668685	OD=74mm ID=20mm H=62mm	
DAFTRK7985	CAB REPAIR KIT	CAB	DAF	XF95, XF105, CF85	12664265 165626654 1399160S1	OD=48mm ID 1=30mm ID 2=25mm H=20mm	
DPD159	EREN BRAKE PAD	CLUTCH & BRAKE	DAF		1628064, WVA: 29159	Length=210.4mm Width=92.5mm Thickness=28.8mm  <b>Front &amp; Rear</b>	
DPD011	EREN BRAKE PAD	CLUTCH & BRAKE	DAF		0906245 WVA: 29211	Length=216mm Width=113.25mm Thickness=29.5mm  <b>Rear</b>	
DPD087	EREN BRAKE PAD	CLUTCH & BRAKE	DAF	XF95, XF105, CF65, CF75, CF85	1439324, 1617343, 1797053, 1800830, 1878030 WVA: 29105, WVA: 29087	Length=246.85mm Width=109.45mm Thickness=30mm  <b>Front &amp; Rear</b>	

TC CODE	DESCRIPTION	GROUP	MAKE	MODEL	OE REFERENCE	REMARK	PICTURE
DPD300	EREN BRAKE PAD	CLUTCH & BRAKE	DAF	XF95, XF105, CF65, CF75, CF85	1439324, 1617343, 1797053, 1800830, 1878030 WVA: 29087, WVA: 29105	Length=246.85mm Width=109.45mm Thickness=30mm  <b>Front &amp; Rear</b>	
DPD301	EREN BRAKE PAD	CLUTCH & BRAKE	DAF		1519637, 1529337, 908142, WVA: 29094	Length=210.7mm Width=92.54mm Thickness=29.5mm  <b>Front &amp; Rear</b>	
DPD565	EREN BRAKE PAD	CLUTCH & BRAKE	DAF	LF	1436901, 1526235, 1534087, WVA: 29088	Length=175.4mm Width=84.1mm Thickness=25mm  <b>Front &amp; Rear</b>	
104080-1	EATON CLUTCH	CLUTCH & BRAKE	DAF	XF105	1625968	AS Tronic AT	

# DEUTZ ENGINE GROUP



## INDEX

<u>GROUP</u>		<u>PAGES</u>
ENGINE & TRANSMISSION GROUP	39	39

TC CODE	DESCRIPTION	GROUP	MAKE	MODEL	OE REFERENCE	REMARK	PICTURE
TD010SX	DAMPER	ENGINE & TRANSMISSION	DEUTZ	912	NA	OD=244mm H=145mm 3 Pulley	
TD013SX	DAMPER	ENGINE & TRANSMISSION	DEUTZ	913	NA	OD=248mm ID=95mm PCD=110mm H=48mm	
TD013SX/G	DAMPER	ENGINE & TRANSMISSION	DEUTZ	913	NA	OD=248mm ID=95mm PCD=110mm H=54mm 1 Groove	
TM224	MOUNTING	ENGINE & TRANSMISSION	DEUTZ	912, 913	NA	OD=80/70mm H=51mm ID=20mm	
TM224B	MOUNTING	ENGINE & TRANSMISSION	DEUTZ		NA	OD=80/70mm H=60mm ID=14/20mm	
TM225	MOUNTING	ENGINE & TRANSMISSION	DEUTZ		NA	OD=95/88mm H=60mm ID20mm	
TM226	MOUNTING	ENGINE & TRANSMISSION	DEUTZ		NA	OD=74mm ID=32mm H=18mm	



# DYNAPAC GROUP



## INDEX

<u>GROUP</u>		<u>PAGES</u>
ENGINE & TRANSMISSION GROUP	41	41







TC CODE	DESCRIPTION	GROUP	MAKE	MODEL	OE REFERENCE	REMARK	PICTURE
TM696	MOUNTING	ENGINE & TRANSMISSION	DYNAPAC	CA-35, CC-421, CA-302	801187	PCD=140/140mm H=76mm	
TM696S	MOUNTING	ENGINE & TRANSMISSION	DYNAPAC	CA-25, CA-25R, CA-21	336742	PCD=125/125mm H=57mm	
TM744	MOUNTING	ENGINE & TRANSMISSION	DYNAPAC	CA-51, CC-551, CA-311	433661501	PCD=140/140mm H=106mm	

# ERF GROUP



## INDEX

<u>GROUP</u>		<u>PAGES</u>
COOLING GROUP	43	43
ENGINE & TRANSMISSION GROUP	43	43

TC CODE	DESCRIPTION	GROUP	MAKE	MODEL	OE REFERENCE	REMARK	PICTURE
TVF275	BORGWARNER FAN	COOLING	ERF	EC410	55RS20115	OD=754mm PCD=214mm ID=177mm 6 Holes	
TVF275FM	FAN MARKET FAN	COOLING	ERF	EC410	55RS20115	OD=754mm PCD=214mm ID=177mm 6 Holes	
TVD011L	BORGWARNER VISCOUS	COOLING	ERF	EC410	55RS251721	<b>Fan Side:</b> ID=177mm PCD=214mm 6 Holes <b>Engine Side:</b> PCD=90mm 6 Holes	
TM222SX	MOUNTING	ENGINE & TRANSMISSION	ERF	EC	NA	H=75mm  <b>SERVICE EXCHANGE ONLY</b>	
TM223	MOUNTING	ENGINE & TRANSMISSION	ERF	EC	NA	W=42mm PCD=147mm	

# FAW GROUP



## INDEX

GROUP

PAGES

SUSPENSION GROUP

45

| 45

TC CODE	DESCRIPTION	GROUP	MAKE	MODEL	OE REFERENCE	REMARK	PICTURE
FAWTA033A	V-STAY	SUSPENSION	FAW	FAW		L=622mm PCD=152/130/130mm Hole ID=25/25/25mm  1=TA033B 2=TA032B	

# FORKLIFT GROUP



## INDEX

GROUP

PAGES

COOLING GROUP

47



47

TC CODE	DESCRIPTION	GROUP	MAKE	MODEL	OE REFERENCE	REMARK	PICTURE
TF033	BORGWARNER FAN	COOLING	FORKLIFT	FORKLIFT	NA	OD=460mm ID=41mm PCD=63mm 4 Holes	

# FUSO GROUP



## INDEX

GROUP

PAGES

COOLING GROUP

49

49





TC CODE	DESCRIPTION	GROUP	MAKE	MODEL	OE REFERENCE	REMARK	PICTURE
FUSOTF047	BORGWARNER FAN	COOLING	FUSO	mitsubishi	NA	OD=720mm PCD=130mm ID=108mm 6 Holes	

# HINO GROUP



## INDEX

<u>GROUP</u>		<u>PAGES</u>
COOLING GROUP	51	51
SUSPENSION GROUP	51	51



TC CODE	DESCRIPTION	GROUP	MAKE	MODEL	OE REFERENCE	REMARK	PICTURE
TF047	BORGWARNER FAN	COOLING	HINO	500	NA	OD=720mm ID=108mm PCD=130mm 6 Holes	
TA009B/SX	BUSH	SUSPENSION	HINO	500	NA	OD=54mm PCD=110mm	
TA009A/H/SX	TORQUE ARM	SUSPENSION	HINO	500	NA	L=615mm 1=TA009B	

# HYSTER GROUP



## INDEX

<u>GROUP</u>		<u>PAGES</u>
SUSPENSION GROUP	53	53

TC CODE	DESCRIPTION	GROUP	MAKE	MODEL	OE REFERENCE	REMARK	PICTURE
TA053B	BUSH	SUSPENSION	HYSTER	HYSTER	NA		
TA054B	BUSH	SUSPENSION	HYSTER	HYSTER	NA		

# INGERSOL RAND GROUP



## INDEX



GROUP

PAGES

ENGINE & TRANSMISSION GROUP

55

55

TC CODE	DESCRIPTION	GROUP	MAKE	MODEL	OE REFERENCE	REMARK	PICTURE
TM243	MOUNTING	ENGINE & TRANSMISSION	INGERSOL RAND	SP, SD, DD	NA		
TM696	MOUNTING	ENGINE & TRANSMISSION	INGERSOL RAND	SD 100, SD 150, DD90	56900205	PCD=140/140mm	

# IVECO GROUP



## INDEX

<u>GROUP</u>		<u>PAGES</u>
COOLING GROUP	57	57
ENGINE & TRANSMISSION GROUP	57	57
STEERING GROUP	57	58
SUSPENSION GROUP	58	59
CLUTCH & BRAKE GROUP	59	60





TC CODE	DESCRIPTION	GROUP	MAKE	MODEL	OE REFERENCE	REMARK	PICTURE
MBTVF13027	FAN	COOLING	IVECO	EUROCARGO	99450016	OD=750mm PCD=200mm ID=180mm 6 Holes	
TVD509	BORGWARNER VISCOUS	COOLING	IVECO	EUROTECH MH	500342509	<b>Fan Side:</b> ID=127mm PCD=152mm 6 Holes <b>Engine Side:</b> 4Holes	
TVD819	BORGWARNER VISCOUS	COOLING	IVECO	EUROTECH MH	500345819	<b>Fan Side:</b> ID=127mm PCD=152mm 6 Holes <b>Engine Side:</b> PCD=130mm 4 Holes	
IVETVD321FM	FAN MARKET VISCOUS	COOLING	IVECO	STRALIS	5801587048		
8PK-BELTS	V-BELT	ENGINE & TRANSMISSION	IVECO	EUROCARGO		Range from: 8PK1230 Till: 8PK1630	
10PK-BELTS	V-BELT	ENGINE & TRANSMISSION	IVECO	EUROCARGO, STRALIS, EUROTRAKKER		Range from: 10PK1720 Till: 10PK1725	
12PK-BELTS	V-BELT	ENGINE & TRANSMISSION	IVECO	STRALIS, EUROSTAR		12PK1815	
YP059	BELT TENSIONER	ENGINE & TRANSMISSION	IVECO	STRALIS	99471920, 99436331		
YP076	BELT TENSIONER	ENGINE & TRANSMISSION	IVECO	STRALIS	504028028		
MBTS1435B	TIE ROD END	STEERING	IVECO	ZETA, MK, TURBOZETA	2966321, 2966635, 4833825, 8193645, 8558533, 8582322, 42484886	Taper 1=20mm Taper 2=22mm M28 <b>Right Hand</b>	

NAMES, NUMBERS, SYMBOLS, DECEPTIONS LISTED IN THIS DOCUMENT ARE USED FOR REFERENCE PURPOSE ONLY AND IT IS NOT IMPLIED THAT ANY PARTS LISTED IS THE PRODUCT OF THESE MANUFACTURERS.

TC CODE	DESCRIPTION	GROUP	MAKE	MODEL	OE REFERENCE	REMARK	PICTURE
MBTS3335B	TIE ROD END	STEERING	IVECO	ZETA, MK, TURBOZETA	2969507, 42484887, 4833826, 8123394, 8193646, 8558536	Taper 1=20mm Taper 2=22mm M28  <b>Left Hand</b>	
MBTS8648B	TIE ROD END	STEERING	IVECO	OM50, OM55, ZETA	7984276, 8558524, 93194627	Taper 1=20mm Taper 2=22mm M24  <b>Left Hand</b>	
TS026	TIE ROD END	STEERING	IVECO	EUROCARGO, EUROFIRE, MK	2980323, 42483520, 42493781, 004833827, 2966688, 42485718, 4833820, 4833827	Taper 1=23,5mm Taper 2=26mm M30  <b>Right Hand</b>	
TS027	TIE ROD END	STEERING	IVECO	EUROCARGO, EUROFIRE, MK	42493782, 2984511, 4833828, 2980129, 4833821, 8122755	Taper 1=23,5mm Taper 2=26mm M30  <b>Left Hand</b>	
TS028	TIE ROD END	STEERING	IVECO	STRALIS, EUROSTAR, EUROTRAKKER, EUROCARGO, EUROFIRE, EUROTECH, TURBOTECH	2966252, 2969808, 42483386, 42488269, 42489573, 4833829, 8122752, 42537936	Taper 1=27mm Taper 2=30mm M30  <b>Right Hand</b>	
TS029	TIE ROD END	STEERING	IVECO	STRALIS, EUROSTAR, EUROTRAKKER, EUROCARGO, EUROFIRE, EUROTECH, TURBOTECH	2984061, 42489395, 42491957, 4802444, 4833830, 8190225, 7138966	Taper 1=27mm Taper 2=30mm M30  <b>Left Hand</b>	
TS10931	GEAR SHIFT LINK	STEERING	IVECO	TURBOSTAR, TURBOTECH, EUROCARGO, EUROCLASS, EURORIDER, BUS	42485639, 8198188	Taper 1=10mm Taper 2=10mm M12  <b>Right Hand</b>	
TS10937	GEAR SHIFT LINK	STEERING	IVECO	TURBOSTAR, TURBOTECH, EUROCARGO, EUROCLASS, EURORIDER, BUS	42485638	Taper 1=10mm Taper 2=10mm M12  <b>Left Hand</b>	
TS10943	GEAR SHIFT LINK	STEERING	IVECO	TURBOTECH, TURBOSTAR, MK	3435786, 86027074, 7981909	Taper 1=10,8mm Taper 2=12mm M14  <b>Right Hand</b>	
TA001B	BUSH	SUSPENSION	IVECO	STRALIS	93192618, 93161720	OD=85mm Hole ID=21mm PCD=152mm	

TC CODE	DESCRIPTION	GROUP	MAKE	MODEL	OE REFERENCE	REMARK	PICTURE
TA003B	BUSH	SUSPENSION	IVECO	EUROTRAKKER	42493431, 93192619, 93162288	OD=95mm Hole ID=21mm PCD=152mm	
TA958B	BUSH	SUSPENSION	IVECO	STRALIS, EUROSTAR	93161960	OD=75mm Hole ID=21mm PCD=130mm	
TA069B	BUSH	SUSPENSION	IVECO	TURBOSTAR, TURBOTECH	02980884	OD=72mm Hole ID=19mm PCD=130mm	
IVETA8372B	BUSH KIT	SUSPENSION	IVECO	STRALIS, EUROSTAR, EUROTRAKKER, EUROCARGO, EUROTECH	93161958S	OD=72mm	
MTA7635B	BUSH	SUSPENSION	IVECO	EUROTRAKKER, EUROCARGO	93192361	OD=75mm Hole ID=19mm PCD=130mm	
IVETA4479A	V-STAY	SUSPENSION	IVECO	STRALIS 430, STRALIS 480, EUROTECH, EUROCARGO, EUROTRAKKER	41034479, 41042050, 41009665, 41028600, 41028598, 08137026, 41002770	L=665mm Hole ID=21/21mm PCD=130/130mm  1=IVETA8372B 2=TA958B	
IVETA10197B	SPRING BUSH	SUSPENSION	IVECO	TURBODAILY	8587681	OD=40mm ID=16mm H=40mm	
IVETA10198B	SPRING BUSH	SUSPENSION	IVECO	TURBODAILY	93808935	OD=40mm ID=16mm H=35mm	
IVETA10074B	STABILIZER BUSH	SUSPENSION	IVECO	EUROCARGO, EUROFIRE, TURBOSTAR, TURBOTECH	4601722	OD=60mm ID=28mm H=50mm	
DPD253	EREN BRAKE PAD	CLUTCH & BRAKE	IVECO	STRALIS, EUROTRAKKER, EUROTECH, EUROCARGO, STRATOR	2996515, 42541062, 500054632, WVA: 29253	Length=247.5mm Width=107.5mm Thickness=29.5mm  <b>Front</b>	

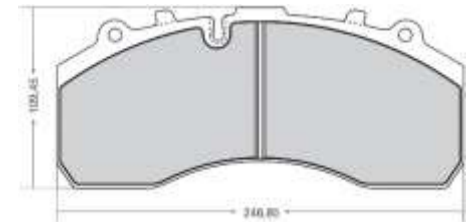
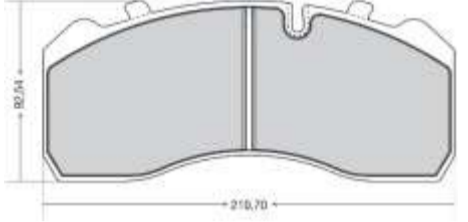
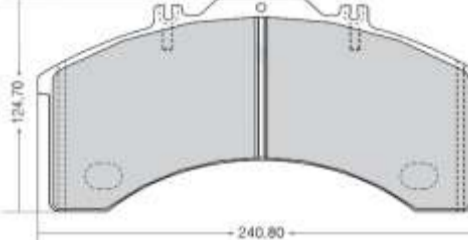
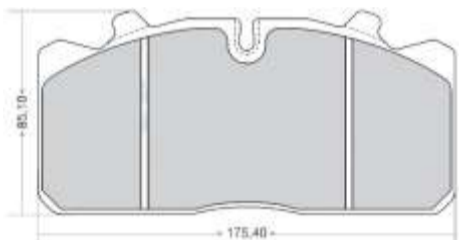
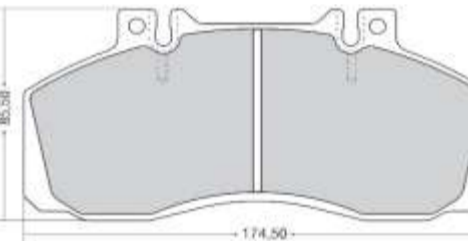
NAMES, NUMBERS, SYMBOLS, DESCRIPTIONS LISTED IN THIS DOCUMENT ARE USED FOR REFERENCE PURPOSE ONLY AND IT IS NOT IMPLIED THAT ANY PARTS LISTED IS THE PRODUCT OF THESE MANUFACTURERS.



TC CODE	DESCRIPTION	GROUP	MAKE	MODEL	OE REFERENCE	REMARK	PICTURE
DPD300	EREN BRAKE PAD	CLUTCH & BRAKE	IVECO	EUROCARGO, EUROTRAKKER, EUROTECH	2995809, 2992348, 2995938, 41211278, 2992476, WVA: 29087, WVA: 29105	Length=247.5mm Width=109.5mm Thickness=29.5mm  <b>Front &amp; Rear</b>	
DPD301	EREN BRAKE PAD	CLUTCH & BRAKE	IVECO	EUROCARGO	2992336, 2996468, WVA: 29094	Length=210.7mm Width=92.54mm Thickness=29.5mm  <b>Front &amp; Rear</b>	
DPD525	EREN BRAKE PAD	CLUTCH & BRAKE	IVECO	EUROCARGO, EUROTECH, EUROSTAR, EUROFIRE	1906191, 1906459, 1906467, WVA: 29011	Length=240.8mm Width=124.7mm Thickness=25mm  <b>Front &amp; Rear</b>	
DPD565	EREN BRAKE PAD	CLUTCH & BRAKE	IVECO	EUROCARGO	1906467, WVA: 29088	Length=175.4mm Width=84.1mm Thickness=25mm  <b>Front &amp; Rear</b>	
DPD679	EREN BRAKE PAD	CLUTCH & BRAKE	IVECO		WVA: 29835	Length=174.5mm Width=85.5mm Thickness=21.7mm  <b>Front</b>	
104082-1	EATON CLUTCH	CLUTCH & BRAKE	IVECO	STRALIS, EUROTECH	122422 3400117801	430mm	

# KOMATSU GROUP



## INDEX

<u>GROUP</u>	<u>PAGES</u>
ENGINE & TRANSMISSION GROUP	62   62

TC CODE	DESCRIPTION	GROUP	MAKE	MODEL	OE REFERENCE	REMARK	PICTURE
TM245	MOUNTING	ENGINE & TRANSMISSION	KOMATSU	D65BD3	NA		
KOMTSM004	SPRING MOUNTING	ENGINE & TRANSMISSION	KOMATSU	HM300-1, HM300-2	56D-50-12312, 56D-50-12313, 56D-50-12314		

# LEYLAND GROUP



## INDEX



GROUP

PAGES

ENGINE & TRANSMISSION GROUP

64

64

TC CODE	DESCRIPTION	GROUP	MAKE	MODEL	OE REFERENCE	REMARK	PICTURE
TM227	MOUNTING	ENGINE & TRANSMISSION	LEYLAND	LEYLAND	NA	PCD=115mm H=63mm ID=16	
TM228	MOUNTING	ENGINE & TRANSMISSION	LEYLAND	LEYLAND	NA	PCD=88mm H=45mm L=108mm W=58mm	
TM228A	MOUNTING	ENGINE & TRANSMISSION	LEYLAND	LEYLAND	NA	PCD=108mm H=45mm L=128mm W=58mm	



# MAN GROUP



## INDEX

<u>GROUP</u>		<u>PAGES</u>
COOLING GROUP	66	69
ENGINE & TRANSMISSION GROUP	69	74
STEERING GROUP	75	77
SUSPENSION GROUP	77	87
CAB GROUP	87	89
CLUTCH & BRAKE GROUP	89	92

TC CODE	DESCRIPTION	GROUP	MAKE	MODEL	OE REFERENCE	REMARK	PICTURE
TF024G	FAN	COOLING	MAN	L2000	51066010261, 51066010102	OD=620mm ID=127mm PCD=146mm PCD=152mm 6 Holes	
TVF012S	BORGWARNER FAN	COOLING	MAN	TGA, F2000	51066010257	OD=754mm PCD=152mm ID=127mm 6 Holes	
TVF016	BORGWARNER FAN	COOLING	MAN	26.552		OD=750mm PCD=214mm ID=178mm 6 Holes	
TVF023	BORGWARNER FAN	COOLING	MAN	F2000	51066010279	OD=704mm PCD=152mm ID=127mm 6 Holes	
TVF023FM	FAN MARKET FAN	COOLING	MAN	F2000	51066010279	OD=704mm PCD=152mm ID=127mm 6 Holes	
TVF258	BORGWARNER FAN	COOLING	MAN	M2000	51066010258	OD=650mm PCD=152mm ID=127mm 6 Holes	
TVF258FM	FAN MARKET FAN	COOLING	MAN	M2000	51066010258	OD=650mm PCD=152mm ID=127mm 6 Holes	
TVF275	BORGWARNER FAN	COOLING	MAN	TGA	51066010275	OD=754mm PCD=214mm ID=177mm 6 Holes	
TVF275FM	FAN MARKET FAN	COOLING	MAN	TGA	51066010275	OD=754mm PCD=214mm ID=177mm 6 Holes	
TVF279	BORGWARNER FAN	COOLING	MAN	D20066	51066010279	OD=704mm PCD=152mm ID=127mm 6 Holes	

NAMES, NUMBERS, SYMBOLS, DECEPTIONS LISTED IN THIS DOCUMENT ARE USED FOR REFERENCE PURPOSE ONLY AND IT IS NOT IMPLIED THAT ANY PARTS LISTED IS THE PRODUCT OF THESE MANUFACTURERS.

TC CODE	DESCRIPTION	GROUP	MAKE	MODEL	OE REFERENCE	REMARK	PICTURE
TVF283	BORGWARNER FAN	COOLING	MAN	TGA	51066010283	OD=750mm PCD=214mm ID=177mm 6 Holes	
TVF283FM	FAN MARKET FAN	COOLING	MAN	TGA	51066010283	OD=750mm PCD=214mm ID=177mm 6 Holes	
MTVF284	BORGWARNER FAN	COOLING	MAN	TGA, TGM, TGS	51066010284	OD=770mm PCD=214mm ID=177mm 6 Holes	
TVF904	BORGWARNER FAN	COOLING	MAN	LM2000	51066010266	OD=600mm PCD=96mm ID=82mm 4 Holes	
MTVD037	BORGWARNER VISCOUS	COOLING	MAN	M2000, L2000, TGM	51066300037	<b>Fan Side:</b> ID=82mm PCD=97mm 4 Holes <b>Engine Side:</b> PCD=63mm 4 Holes	
TVD018	BORGWARNER VISCOUS	COOLING	MAN	F2000	51066300068	<b>Fan Side:</b> ID=127mm PCD=152mm 6 Holes <b>Engine Side:</b> PCD=90mm 4 Holes	
TVD060	BORGWARNER VISCOUS	COOLING	MAN	F2000	51066300066, 51066300060	<b>Fan Side:</b> ID=127mm PCD=152mm 6 Holes <b>Engine Side:</b> PCD=90mm 4 Holes	
TVD067	BORGWARNER VISCOUS	COOLING	MAN	M2000, TGM	51066300067	<b>Fan Side:</b> ID=127mm PCD=152mm 6 Holes <b>Engine Side:</b> PCD=63mm 4 Holes	
TVD067FM	FAN MARKET VISCOUS	COOLING	MAN	M2000, TGM	51066300067	<b>Fan Side:</b> ID=127mm PCD=152mm 6 Holes <b>Engine Side:</b> PCD=63mm 4 Holes	
TVD071	BORGWARNER VISCOUS	COOLING	MAN	L2000, M2000	51066300071	<b>Fan Side:</b> ID=82mm PCD=97mm 4 Holes <b>Engine Side:</b> PCD=63mm 4 Holes	











TC CODE	DESCRIPTION	GROUP	MAKE	MODEL	OE REFERENCE	REMARK	PICTURE
TVD074	BORGWARNER VISCIOUS	COOLING	MAN	M2000, L2000, TGM, TGL	51066300074	<b>Fan Side:</b> ID=127mm PCD=152mm 6 Holes <b>Engine Side:</b> 6 Holes	
TVD082	BORGWARNER VISCIOUS	COOLING	MAN	TGM	51066300082	<b>Fan Side:</b> ID=127mm PCD=152mm 6 Holes <b>Engine Side:</b> 4 Holes	
TVD119	BORGWARNER VISCIOUS	COOLING	MAN	TGA, TGS, TGX	51066300119	<b>Fan Side:</b> ID=177mm PCD=214mm 6 Holes <b>Engine Side:</b> PCD=90mm 4 Holes <b>6 Pin</b>	
TVD119FM	FAN MARKET VISCIOUS	COOLING	MAN	TGA, TGS, TGX	51066300119	<b>Fan Side:</b> ID=177mm PCD=214mm 6 Holes <b>Engine Side:</b> PCD=90mm 4 Holes <b>6 Pin</b>	
TVD129/130	BORGWARNER VISCIOUS	COOLING	MAN	TGA	51066300129, 51066300130, 51066300106	<b>Fan Side:</b> ID=177mm PCD=214mm 6 Holes <b>Engine Side:</b> PCD=90mm 4 Holes <b>2 Pin</b>	
TVD129/130FM	FAN MARKET VISCIOUS	COOLING	MAN	TGA	51066300129, 51066300130, 51066300106	<b>Fan Side:</b> ID=177mm PCD=214mm 6 Holes <b>Engine Side:</b> PCD=90mm 4 Holes <b>2 Pin</b>	
TVD131	BORGWARNER VISCIOUS	COOLING	MAN	TGA, TGS, TGX	51066300131	<b>Fan Side:</b> ID=127mm PCD=152mm 6 Holes <b>Engine Side:</b> PCD=90mm 4 Holes <b>2 Pin</b>	
TVD131FM	FAN MARKET VISCIOUS	COOLING	MAN	TGA, TGS, TGX	51066300131	<b>Fan Side:</b> ID=127mm PCD=152mm 6 Holes <b>Engine Side:</b> PCD=90mm 4 Holes <b>2 Pin</b>	
TVD141	BORGWARNER VISCIOUS	COOLING	MAN	TGA, TGS, TGX	51066300141, 51066300122, 51066300137	<b>Fan Side:</b> ID=177mm PCD=214mm 6 Holes <b>Engine Side:</b> PCD=90mm 4 Holes <b>6 Pin</b>	
TVD144	BORGWARNER VISCIOUS	COOLING	MAN	TGS	51066300144	<b>Fan Side:</b> ID=177mm PCD=214mm 6 Holes <b>Engine Side:</b> PCD=90mm 4 Holes <b>2 Pin</b>	

TC CODE	DESCRIPTION	GROUP	MAKE	MODEL	OE REFERENCE	REMARK	PICTURE
TD018	DAMPER	COOLING	MAN	F2000, M2000, F90, BUS	51022010099		
YP002	VIBRATION DAMPER	COOLING	MAN	TGA	51066040061		
YP025	FAN HUB ASSEMBLY	COOLING	MAN	TGA	51066006066, 51066006075, 51066006077, 51066006088		
MTM0011	MOUNTING	ENGINE & TRANSMISSION	MAN	M2000, L2000, F2000, F90	81962100011, 81962100022	OD=85mm H=60mm M12  <b>Front</b>	
MTM13300	MOUNTING	ENGINE & TRANSMISSION	MAN	TGM, TGL	81962100598, 81962100582, 81962100583	Ax=140/150 d=Ø13 M14x1,5/Ax=35  <b>Rear</b>	
MTM13301	MOUNTING	ENGINE & TRANSMISSION	MAN	TGM, TGL	81962100612, 81962100635	Ax=140/75 d=Ø13/M12x1,5 M16x1,5  <b>Front</b>	
MTM7355	MOUNTING	ENGINE & TRANSMISSION	MAN	11.192, 15.192, 16.168, 16.102, 22.190	81962100213	A=140 B=55 h=55 M10	
MTM7487	MOUNTING	ENGINE & TRANSMISSION	MAN	M2000, F90	81960200205, 93962100510, 81960200235	OD=72mm H=84mm  <b>Rear</b>	
MTM7488	MOUNTING	ENGINE & TRANSMISSION	MAN	M2000, F90	81960200239, 83962100509, 81962100202	OD=59mm H=56.5mm  <b>Front</b>	
MTM7539	MOUNTING	ENGINE & TRANSMISSION	MAN	F2000, F90, S2000	81960200340, 81960200372	OD=70mm H=72mm  <b>Front</b>	

NAMES, NUMBERS, SYMBOLS, DESCRIPTIONS LISTED IN THIS DOCUMENT ARE USED FOR REFERENCE PURPOSE ONLY AND IT IS NOT IMPLIED THAT ANY PARTS LISTED IS THE PRODUCT OF THESE MANUFACTURERS.

TC CODE	DESCRIPTION	GROUP	MAKE	MODEL	OE REFERENCE	REMARK	PICTURE
MTM7666	MOUNTING	ENGINE & TRANSMISSION	MAN	M2000, F90, L2000	81960200382, 88962100004	OD=72mm H=84mm Shore A55  <b>Rear</b>	
TM072	MOUNTING	ENGINE & TRANSMISSION	MAN	TGA	81962106072, 81962106065, 81962106071	M 18x2  <b>Rear</b>	
TM212	MOUNTING	ENGINE & TRANSMISSION	MAN	16.281, 19.281, 20.240, 26.240, 26.280, 26.281, 26.321, 30.240, 23.231	81962100242, 81962100227	M 16x1.5 Ax=40 d=Ø15x20 Ax=70x175	
TM213	MOUNTING	ENGINE & TRANSMISSION	MAN	F2000, M2000, L2000	81960200403, 81960200391	OD=72mm H=84mm Shore A45  <b>Front</b>	
TM214	MOUNTING	ENGINE & TRANSMISSION	MAN	TGA, F90	81962100238, 81962100198, 81962100175, 81962100166	M 16x1.5 d=Ø13x17,5 Ax=70x149,5	
TM216	MOUNTING	ENGINE & TRANSMISSION	MAN	16.240, 19.281, 22.280, 26.281, 26.321, 30.281, 32.281	81962100184, 81962100149, 81962100129, 81962100371	L=140mm W=65mm H=55mm M10	
TM217	MOUNTING	ENGINE & TRANSMISSION	MAN	TGA, F2000, F90	81960200341, 81960200385, 81960200418, 81960200373, 81960200408	OD=70mm H=85mm  <b>Rear</b>	
TM217B	MOUNTING	ENGINE & TRANSMISSION	MAN	TGA, F2000, F90	81960200341, 81960200385, 81960200418, 81960200373, 81960200408	OD=70mm H=85mm  <b>Rear SPLIT TIPE</b>	
TM264	MOUNTING	ENGINE & TRANSMISSION	MAN	TGA, TGS, TGX	81962100597, 81962100592, 81962100572	M18x1,5 Ax=40 d=Ø15 Ax=100x200  <b>Rear</b>	
TM265	MOUNTING	ENGINE & TRANSMISSION	MAN	TGA, TGS, TGX	81962100571, 81962100577, 81962100588	M18x1,5 M14x1,5 Ax=75x140  <b>Front</b>	

TC CODE	DESCRIPTION	GROUP	MAKE	MODEL	OE REFERENCE	REMARK	PICTURE
TM553	MOUNTING	ENGINE & TRANSMISSION	MAN	TGA	81962100553, 81962100525, 81962100574	M 16x1,5  <b>Front</b>	
TM745	MOUNTING	ENGINE & TRANSMISSION	MAN	F90	81962100089	OD=100mm H=75mm M 16x1.5	
TM800	MOUNTING	ENGINE & TRANSMISSION	MAN	F90	81962100089	OD=100mm H=70mm M16  <b>Male Male</b>	
MTM9590	RUBBER METAL MOUNTING	ENGINE & TRANSMISSION	MAN	TGA, TGS, TGX, F2000	81062250005	ID=9mm H=18mm  <b>Left Hand</b>	
MTM9590	RUBBER METAL MOUNTING	ENGINE & TRANSMISSION	MAN	TGA, TGS, TGX, F2000	81062250006	ID=9mm H=18mm  <b>Right Hand</b>	
MTSH11158	SILICON HOSE	ENGINE & TRANSMISSION	MAN	TGA, TGX, F2000, F90	81963050135, 81963010399, 81963050144, 81963050298	ID=60mm L=80 X 80mm	
SH132	SILICON HOSE	ENGINE & TRANSMISSION	MAN	F90	81963200132	ID=100mm L=180mm	
SH134	SILICON HOSE	ENGINE & TRANSMISSION	MAN	TGA, TGS, TGX, F2000, F90	81963050134, 51963050018, 81963050095, 51963050021, 81963050223, 81963050226	ID60mm L=85X85mm	
SH168	SILICON HOSE	ENGINE & TRANSMISSION	MAN	M2000, L2000	81963200168	ID=65mm ID=50mm L=190mm 3 HUMPS	
SH170	SILICON HOSE	ENGINE & TRANSMISSION	MAN	26.23	81963200170	ID=65mm L=110mm	

TC CODE	DESCRIPTION	GROUP	MAKE	MODEL	OE REFERENCE	REMARK	PICTURE
SH175	SILICON HOSE	ENGINE & TRANSMISSION	MAN	TGA, TGS, TGX, F2000, M2000, L2000, F90	81963200175, 81963200115, 81963200148	ID=65mm L=180mm 4 HUMP	
SH190	SILICON HOSE	ENGINE & TRANSMISSION	MAN	26.281	51963300190	ID=75mm L=120mm	
SH300	SILICON HOSE	ENGINE & TRANSMISSION	MAN	26.23	81963300300	ID=50mm L=110mm	
SH359	SILICON HOSE	ENGINE & TRANSMISSION	MAN	F90, M90	51963300359	ID=50mm L=80mm	
SH587	SILICON HOSE	ENGINE & TRANSMISSION	MAN	F90	81963010587, 81963010543, 81963010591, 81963010592	ID=100mm L=240mm 5 HUMP	
SH594	SILICON HOSE	ENGINE & TRANSMISSION	MAN	NG, NL, SL	81963010594	ID=90mm L=120mm	
SH600	SILICON HOSE	ENGINE & TRANSMISSION	MAN	NG, NL, SL	81963010600	ID=100mm L=130mm	
SH602	SILICON HOSE	ENGINE & TRANSMISSION	MAN	NG, NL, SL	81963010602	ID=70mm L=100mm	
SH624	SILICON HOSE	ENGINE & TRANSMISSION	MAN	NG, NL, SL	81963010624	ID=100mm L=80mm	
SH639	SILICON HOSE	ENGINE & TRANSMISSION	MAN	F2000, F90	81963010639, 81963010551	ID=60mm ID=70mm L=90mm	











NAMES, NUMBERS, SYMBOLS, DECEPTIONS LISTED IN THIS DOCUMENT ARE USED FOR REFERENCE PURPOSE ONLY AND IT IS NOT IMPLIED THAT ANY PARTS LISTED IS THE PRODUCT OF THESE MANUFACTURERS.



TC CODE	DESCRIPTION	GROUP	MAKE	MODEL	OE REFERENCE	REMARK	PICTURE
SH668	SILICON HOSE	ENGINE & TRANSMISSION	MAN	M2000, L2000, F90	81963010668	ID=90mm L=290mm 7 HUMP	
SH900	SILICON HOSE	ENGINE & TRANSMISSION	MAN	TGA, TGM, TGS, TGX, F2000, F90	81963010900	ID=90mm L=285mm 7 HUMP	
MANRH898	RADIATOR HOSE	ENGINE & TRANSMISSION	MAN	TGA, TGX	81963010898, 82963010006	ID=60 x 60mm L=620mm	
MTRH8408	RADIATOR HOSE	ENGINE & TRANSMISSION	MAN	TGA, TGS, F2000	81963010677	ID=60mm ID=60mm L=430mm	
MTRH8446	RADIATOR HOSE	ENGINE & TRANSMISSION	MAN	TGA, TGS, F2000	81963010677	ID=60mm ID=60mm L=430mm	
MTRH8736	RADIATOR HOSE	ENGINE & TRANSMISSION	MAN	F2000	81963050129	ID=60mm ID=60mm L=630mm	
MTBEL7602	BELLOW	ENGINE & TRANSMISSION	MAN	F2000, M2000, F90	81964200324	OD=230mm ID=32mm	
MTGS10023K	GEAR SHIFT REPAIR KIT	ENGINE & TRANSMISSION	MAN	F2000, M2000, L2000, F90	81326706199	M10x1,5 M16x1,5	
MTIME7640	INSUL METERIAL ELEMENTE	ENGINE & TRANSMISSION	MAN	F2000, M2000, F90	81326160007, 81326160002, 81326160005, 81326160006	OD=242mm H=80mm	
4PK-BELTS	V-BELT	ENGINE & TRANSMISSION	MAN	TGM		4PK1390	











NAMES, NUMBERS, SYMBOLS, DECEPTIONS LISTED IN THIS DOCUMENT ARE USED FOR REFERENCE PURPOSE ONLY AND IT IS NOT IMPLIED THAT ANY PARTS LISTED IS THE PRODUCT OF THESE MANUFACTURERS.

TC CODE	DESCRIPTION	GROUP	MAKE	MODEL	OE REFERENCE	REMARK	PICTURE
5PK-BELTS	V-BELT	ENGINE & TRANSMISSION	MAN	TGA		Range from: 5PK1482 Till: 5PK1525	
8PK-BELTS	V-BELT	ENGINE & TRANSMISSION	MAN	TGA, TGM, TGS, TGX, F2000, F90		Range from: 8PK880 Till: 8PK1920	
9PK-BELTS	V-BELT	ENGINE & TRANSMISSION	MAN	TGA		9PK1725	
10PK-BELTS	V-BELT	ENGINE & TRANSMISSION	MAN	TGA, TGM, TGS, TGX, F2000, F90		Range from: 10PK1688 Till: 10PK2335	
12PK-BELTS	V-BELT	ENGINE & TRANSMISSION	MAN	L2000		Range from: 12PK1300 Till: 12PK1515	
14PK-BELTS	V-BELT	ENGINE & TRANSMISSION	MAN	TGA		14PK1306	
YP023 / 13258	BELT TENSIONER	ENGINE & TRANSMISSION	MAN	TGA	51958007477, 51958007466, 51958007459, 51958007436, 51958007429		
YP024	BELT TENSIONER	ENGINE & TRANSMISSION	MAN	TGA	51958007386, 51958007390, 51958007418, 51958007480, 51958007435		
YP043	BELT TENSIONER	ENGINE & TRANSMISSION	MAN	TGA	51958007385, 51958007394, 51958007397, 51958007396, 51958007393		
YP083	BELT TENSIONER	ENGINE & TRANSMISSION	MAN	TGA	51958007519, 51958007489, 51958007446, 51958007473		

TC CODE	DESCRIPTION	GROUP	MAKE	MODEL	OE REFERENCE	REMARK	PICTURE
MANTS6133	DRAGLINK	STEERING	MAN	TGA, TGS, TGX	81466116133, 81466116097, 81466116132, 81466116087, 81466116197, 81466116096, 81466116198	Taper 1=27mm Taper 2=30mm Length=995mm  1=TS028 2=Crimped	
MTS6067A	DRAGLINK	STEERING	MAN	L2000	81466106708, 81466116067	Taper 1=27mm Taper 2=30mm Length = 905mm  1=TS028 2=Crimped	
TS722A	DRAGLINK	STEERING	MAN	F90, F2000	81466106722, 81466106360, 81466106334, 81466106333, 81466106354, 81466106361, 81466106355, 81466106721	Taper 1=27mm Taper 2=30mm Length=1035mm  1=TS028 2=Crimped	
MTS10132A	TIE ROD	STEERING	MAN	TGA, TGM, TGS, F2000, M2000, L2000, F90	81467106122, 81467106379, 81467116736, 81467106380, 81467106167, 81467106830, 81467106194, 81467106836	Taper 1=27mm Taper 2=30mm Length=1588mm  1=TS028 2=Crimped	
MTS6722A	TIE ROD	STEERING	MAN	BUS	81467116722, 81467106902	Taper 1=27mm Taper 2=30mm Length=1676mm  1=TS028 2=Crimped	
MTS6851A	TIE ROD	STEERING	MAN	L2000,M2000	81467106395, 81467106852, 81467116719, 81467116729	Taper 1=20mm Taper 2=22mm Length=1630mm  1=MBTS1435B 2=MBTS3335B	
MTS6711A	TIE ROD	STEERING	MAN	M2000	81467116785, 81467116846, 81467106933, 81467106934, 81467116711	Taper 1=23,5mm Taper 2=26mm Length=1650mm  1=TS11580B 2=Crimped	
MTS14590A	TIE ROD	STEERING	MAN	M2000	81467116785, 81467116846, 81467106933, 81467106934, 81467116711	Taper 1=23,5mm Taper 2=26mm Length=1650mm  1=TS11580B 2=Crimped	
TS112A	TIE ROD	STEERING	MAN	TGX, TGA, TGS	81467106112, 81467106163, 81467106354, 81467106353, 81467106198, 81467106165, 81467106361, 81467116820	Taper 1=27mm Taper 2=30mm Length=1652mm  1=TS028 2=TS029	
TS860A	TIE ROD	STEERING	MAN	TGA, TGM, TGS, TGX, M2000, F2000	81467116860, 81467116859, 81467116921, 81467116883, 81467116861, 81467116858, 81467116773, 81467116920	Taper 1=27mm Taper 2=30mm Length=1680mm  1=MTS11563B 2=Crimped	











NAMES, NUMBERS, SYMBOLS, DECEPTIONS LISTED IN THIS DOCUMENT ARE USED FOR REFERENCE PURPOSE ONLY AND IT IS NOT IMPLIED THAT ANY PARTS LISTED IS THE PRODUCT OF THESE MANUFACTURERS.

TC CODE	DESCRIPTION	GROUP	MAKE	MODEL	OE REFERENCE	REMARK	PICTURE
MBTS1435B	TIE ROD END	STEERING	MAN	L2000, G90, M2000	81953016060, 81953016240, 81953016140, 81953016135, 81953016249	Taper 1=20mm Taper 2=22mm M28  <b>Right Hand</b>	
MBTS3335B	TIE ROD END	STEERING	MAN	L2000, M2000, F2000	81953010079, 81953016139, 81953016222	Taper 1=20mm Taper 2=22mm M28  <b>Left Hand</b>	
MTS11563B	TIE ROD END	STEERING	MAN	TGA, TGS, TGM, TGX, M2000	81953016288	Taper 1=27mm Taper 2=30mm M30  <b>Right Hand</b>	
TS015	TIE ROD END	STEERING	MAN	F2000, M2000, F90, M90, TGA	81953010015, 81953016237, 81953016087, 81953016030, 81953016043, 81953010083, 81953016050, 81953016054	Taper 1=27mm Taper 2=30mm M30  <b>Left Hand</b>	
TS016	TIE ROD END	STEERING	MAN	F2000, M2000, F90, M90, TGA	81953010016, 81953010084, 81953016048, 81953016112, 81953016049, 81953016126, 81953016053, 81953016143	Taper 1=27mm Taper 2=30mm M30  <b>Right Hand</b>	
TS026	TIE ROD END	STEERING	MAN	M2000, L2000, M90	81953010014, 81953010064, 81953016067, 81953016162, 81953016239, 90804153111, 81953016360, 81953010042	Taper 1=23,5mm Taper 2=26mm M30  <b>Right Hand</b>	
TS027	TIE ROD END	STEERING	MAN	M2000, L2000, M90	81953010013, 81953010074, 81953016068, 81953013107, 90804153113, 81953016361, 81953016163	Taper 1=23,5mm Taper 2=26mm M30  <b>Left Hand</b>	
TS10140B	TIE ROD END	STEERING	MAN	E2000	81953016295	Taper 1=34,3mm Taper 2=38mm M38  <b>Right Hand</b>	
TS10931	GEAR SHIFT LINK	STEERING	MAN	F90, F2000, G90, L2000, M90, M2000	81953016064, 81953016130, 81953016170, 81953016173	Taper 1=10mm Taper 2=10mm M12  <b>Right Hand</b>	
TS10937	GEAR SHIFT LINK	STEERING	MAN	F90, F2000, G90, L2000, M90, M2000	81953016063, 81953016131, 81953016171, 81953016174	Taper 1=10mm Taper 2=10mm M12  <b>Left Hand</b>	

TC CODE	DESCRIPTION	GROUP	MAKE	MODEL	OE REFERENCE	REMARK	PICTURE
TS10943	GEAR SHIFT LINK	STEERING	MAN	M90, M2000	81953010038, 81953010045, 81953016016, 81953016169, 81953016172, 81953016176	Taper 1=10,8mm Taper 2=12mm M14  <b>Right Hand</b>	
TS11580B	TIE ROD END	STEERING	MAN	TGM	81953016270	Taper 1=23,5mm Taper 2=26mm M30  <b>Right Hand</b>	
MTA0038B	BUSH	SUSPENSION	MAN	M2000	81953020038, 81953020057	OD=67mm Hole ID=15mm PCD=100mm	
MTA6089B	BUSH	SUSPENSION	MAN	F2000, M2000, L2000, F90	81432706089	OD=67mm Hole ID=19mm PCD=115mm	
MTA6119B	BUSH	SUSPENSION	MAN	TGM, TGA, TGS, TGX, F2000, F90	81432706119	OD=75mm Hole ID=19mm PCD=115mm	
MTA6315B	BUSH	SUSPENSION	MAN	TGM	81432206315	OD=67mm Hole ID=19mm PCD=130mm	
MTA7635B	BUSH	SUSPENSION	MAN	TGA, TGS, TGM, F2000, F90, M2000	81432306061	OD=75mm Hole ID=19mm PCD=130mm	
MTA9613B	BUSH	SUSPENSION	MAN	TGA, TGS, TGX	81432706097S, 81432706111	OD=75mm Hole ID=23mm PCD=130mm	
TA003B	BUSH	SUSPENSION	MAN	TGA, TGS, TGM, F2000, F90, M2000	81432706040, 81432706045, 81432706069	OD=95mm Hole ID=21mm PCD=152mm	
TA003B/FM	BUSH	SUSPENSION	MAN	S2000	81432206204	OD=95mm ID=53,5mm H=72,5mm	

TC CODE	DESCRIPTION	GROUP	MAKE	MODEL	OE REFERENCE	REMARK	PICTURE
TA018B	BUSH	SUSPENSION	MAN	TGA, TGS, TGX, F2000	81432206250, 81432206369	OD=85mm Hole ID=19mm PCD=130mm	
TA033B	BUSH	SUSPENSION	MAN	TGX, TGA, TGS, TGM, F2000	81432706110	OD=100mm Hole ID=25mm PCD=152mm	
TA034B	BUSH	SUSPENSION	MAN	TGA, TGS, TGX, M2000	81432706101, 81432706139, 81432706109	OD=85mm Hole ID=25mm PCD=152mm	
TA126B	BUSH	SUSPENSION	MAN	TGA, TGS, TGX, F2000	81432706126	OD=85mm Hole ID=23mm PCD=130mm	
VOLTA1187B	BUSH	SUSPENSION	MAN	F2000, M2000, F90	81432306051, 81432306068, 81432706064, 81432306072	OD=75mm Hole ID=17mm PCD=115mm	
VOLTA5988B	BUSH	SUSPENSION	MAN	L2000	81432206202	OD=67mm Hole ID=17mm PCD=100mm	
VOLTA8616B	BUSH	SUSPENSION	MAN	TGA, TGS, TGX, F2000, F90	81432206241	OD=95mm Hole ID=21mm PCD=130mm	
MTA6043B	BUSH KIT	SUSPENSION	MAN	F90	81432306043	OD=80mm PCD=130mm Hole ID=19mm	
MTA7783B	BUSH KIT	SUSPENSION	MAN	F90	81432306043	OD=80mm PCD=130mm Hole ID=19mm	
TA042B	BUSH KIT	SUSPENSION	MAN	F2000, F90	81953016133	OD=90mm H=35mm	

NAMES, NUMBERS, SYMBOLS, DESCRIPTIONS LISTED IN THIS DOCUMENT ARE USED FOR REFERENCE PURPOSE ONLY AND IT IS NOT IMPLIED THAT ANY PARTS LISTED IS THE PRODUCT OF THESE MANUFACTURERS.

TC CODE	DESCRIPTION	GROUP	MAKE	MODEL	OE REFERENCE	REMARK	PICTURE
TA069B	BUSH KIT	SUSPENSION	MAN	TGA, TGS, TGX, F2000, M2000, F90	81432206108, 81432206132, 81432206109, 81432206290	OD=72mm Hole ID=19mm PCD=130mm	
TA024B	BUSH KIT	SUSPENSION	MAN	TGA, F2000, TGS, TGX	81432706080	D=90mm	
MANTA6196A	TORQUE ARM	SUSPENSION	MAN	TGA, F2000	81432206196, 81432206232, 81432206233	L=596mm Hole ID=Ø19/19mm PCD=130/130mm  1=TA018B	
MTA6140A	TORQUE ARM	SUSPENSION	MAN	M90, M2000	81432206140, 81432209140	L=596mm Hole ID=19/18,5mm PCD=130/110mm  1=TA069B 2=11819	
MTA8045A	TORQUE ARM	SUSPENSION	MAN	TGA, TGS, TGX, F2000, M2000, F90	81432306037, 81432309037	L=500mm Hole ID=19/19mm PCD=130/130mm  1=MTA6043B	
MTA8059A	TORQUE ARM	SUSPENSION	MAN	TGA, TGS, TGX, F2000, M2000, F90	81432206052, 81432206028, 81432206020, 81432206035, 81432206013, 81432206040, 81432206012, 81432206041	L=565mm Hole ID=19/19mm PCD=130/130mm  1=TA018B	
MTA8060A	TORQUE ARM	SUSPENSION	MAN	TGA, TGS, TGX, F2000, F90	81432206090, 81432209092, 81432206067, 81432206068, 81432206092	L=590mm Hole ID=19/19mm PCD=130/130mm  1=TA018B	
MTA9358A	TORQUE ARM	SUSPENSION	MAN	TGX, TGA, TGS, F2000	81432206229, 81432206304, 81432206305, 81432206380	L=572mm Hole ID=19/19mm PCD=130/130mm  1=MTA7635B	
TA069A	TORQUE ARM	SUSPENSION	MAN	TGA, TGS, TGX, F2000, M2000, F90	81432206129, 81432206096, 81432206097, 81432206098, 81432306014, 81432306030, 81432209096, 81432209129	L=571mm Hole ID=19/19mm PCD=130/130mm  1=TA069B	
UNITA9362A	TORQUE ARM	SUSPENSION	MAN	HOCL	81432306038, 81432306039	L=755mm Hole ID=19/19mm PCD=130/130mm  1=TA069B	

NAMES, NUMBERS, SYMBOLS, DESCRIPTIONS LISTED IN THIS DOCUMENT ARE USED FOR REFERENCE PURPOSE ONLY AND IT IS NOT IMPLIED THAT ANY PARTS LISTED IS THE PRODUCT OF THESE MANUFACTURERS.

TC CODE	DESCRIPTION	GROUP	MAKE	MODEL	OE REFERENCE	REMARK	PICTURE
MANTA9053A	V-STAY	SUSPENSION	MAN	M2000, F90, M90	81432709053, 81432706053	L=693,5mm PCD=115/115mm Hole ID=Ø19/19mm  1=TA025B/S 2=MTA6119B	
MTA6129A	V-STAY	SUSPENSION	MAN	TGM	81432706129, 81432706130, 81432706131	L=642,7mm Hole ID=25/19/19mm PCD=152/115/115mm  1=TA034B 2=MTA6089B	
MTA8184A	V-STAY	SUSPENSION	MAN	TGA, TGM, TGS, TGX, F2000	81432706087, 81432706088, 81432706094, 81432706095	L=627mm Hole ID=25/25/25mm PCD=152/130/130mm  1=TA033B 2=TA126B	
TA056A	V-STAY	SUSPENSION	MAN	F2000, F90	81432706056, 81432706067, 81432706075, 81432709056, 81432706081	L=627mm Hole ID=23/23mm PCD=152/152mm  1=TA024B 2=TA003B	
TA078A	V-STAY	SUSPENSION	MAN	F2000, F90	81432706078, 81432706057, 81432706055, 81432706054, 81432706034, 81432706030, 81432706074, 81432709078	L=621mm PCD=152/152mm Hole ID=23/23mm  1=TA024B 2=TA042B	
TA096A	V-STAY	SUSPENSION	MAN	TGA, TGS, TGX	81432706096, 81432706114, 81432206221, 81432706121	L=627mm PCD=130/130mm Hole ID=23/23mm  1=TA024B 2=TA018B	
TA097A	V-STAY	SUSPENSION	MAN	M2000	85432706001	L=627mm Hole ID=25/23/23mm PCD=152/152/152mm  1=TA034B 2=TA032B/L	
MTSA6794	SHOCK ABSORBER	SUSPENSION	MAN	F2000	81437016794, 81437016888, SACHS131256, SACHS125857	OPEN LENGTH=678 CLOSED LENGTH=415 UPPER MOUNT DIMENSION=M14x64 LOWER MOUNT DIMENSION=16x50	
MTA0060B	SPRING EYE BUSH	SUSPENSION	MAN	M2000, L2000	81437220060	OD=57mm ID=20mm H=84mm	
MTA0061B	SPRING EYE BUSH	SUSPENSION	MAN	F2000	81437220061, 81437220044, 83437220001	OD=70mm ID=24mm H=95mm	



TC CODE	DESCRIPTION	GROUP	MAKE	MODEL	OE REFERENCE	REMARK	PICTURE
MTA0062B	SPRING EYE BUSH	SUSPENSION	MAN	F2000	81437220062	OD=70mm ID=24mm H=105mm	
MTA0070B	SPRING EYE BUSH	SUSPENSION	MAN	TGA, TGX	81437220070, 81962100616	OD=65mm ID=24mm H=95mm	
MTA0087B	SPRING EYE BUSH	SUSPENSION	MAN	TGX, TGA, TGS, F2000	81437220087, 81962100634	OD=65mm ID=24mm H=100mm	
MTA7856B	SPRING EYE BUSH	SUSPENSION	MAN	M2000, L2000	81437220051, 81437220078, 81437220079	OD=57mm ID=20mm H=84mm	
MTA9232B	SPRING EYE BUSH	SUSPENSION	MAN	TGX, TGA, TGS, F2000	81437220087, 81962100634	OD=65mm ID=24mm H=100mm	
MTA9236B	SPRING EYE BUSH	SUSPENSION	MAN	TGA, TGS, TGX, TGM	81437220091	OD=62mm ID=24mm H=95mm	
MTA9237B	SPRING EYE BUSH	SUSPENSION	MAN	TGM	81437220092	OD=62mm ID=20mm H=95mm	
MTA7725B	RUBBER BUSH	SUSPENSION	MAN	TGA, TGM	81960200250, 81960200231, 81960200252,	OD=50mm ID=16mm H=95mm	
MTM7734	SPRING MOUNTING	SUSPENSION	MAN	TGX, TGA, TGS	81434070109, 83434070509, 81434075003, 81434070110	A=110 B=84 h=13	
MTSM7815	SPRING MOUNTING	SUSPENSION	MAN	TGA, TGM, TGS, TGX, F2000, F90	81434006484, 83960200506	A=80 B=105 h=13	

NAMES, NUMBERS, SYMBOLS, DESCRIPTIONS LISTED IN THIS DOCUMENT ARE USED FOR REFERENCE PURPOSE ONLY AND IT IS NOT IMPLIED THAT ANY PARTS LISTED IS THE PRODUCT OF THESE MANUFACTURERS.



TC CODE	DESCRIPTION	GROUP	MAKE	MODEL	OE REFERENCE	REMARK	PICTURE
MTSM7858	SPRING MOUNTING	SUSPENSION	MAN	F2000	81434070102	A=100 B=140 h=17.5	
MTSM8004	SPRING MOUNTING	SUSPENSION	MAN	TGA, TGL, TGS, TGM, L2000	81434070132	A=127 B=110 H=35	
MTSM14682	SPRING MOUNTING	SUSPENSION	MAN	TGA, TGM, TGS, F2000, M2000	81434070112	A=80 B=120 h=17,5	
TSM002	SPRING MOUNTING	SUSPENSION	MAN	F9, F2000	81962105022, 81962105021, 81962105023	A=120 B=200 H=127	
TSM0554	SPRING MOUNTING	SUSPENSION	MAN	TGA, TGM, TGS, TGX	81962100554, 81962100547	Ax1=115 Ax2=180 A=157 B=265 M20x2 <b>Right Hand</b>	
TSM0555	SPRING MOUNTING	SUSPENSION	MAN	TGA, TGM, TGS, TGX	81962100555, 81962100548	Ax1=115 Ax2=180 A=157 B=265 h=142 M20x2 <b>Left Hand</b>	
MTSB8446	SPRING MOUNTING BOLT	SUSPENSION	MAN	TGA, TGM, TGS, TGX, F2000	06014944935	M.20x2 h=260 10,9	
MTSB8447	SPRING MOUNTING BOLT	SUSPENSION	MAN	TGA, TGM, TGS, TGX, F2000	06014944933	M20x2 h=240 10,9	
MTM6006	RUBBER BUSH	SUSPENSION	MAN	TGA, TGS, TGX, F2000, M2000, L2000, F90	81960200172, 81960206006	OD=96mm ID=19mm H=96mm	
MTA0040B	STABILIZER BUSH	SUSPENSION	MAN	TGA, TGM, TGS, TGX, F2000, M2000, F90	81437220040, 81437220042, 81437220041	OD=82mm ID=55mm H=70mm	

TC CODE	DESCRIPTION	GROUP	MAKE	MODEL	OE REFERENCE	REMARK	PICTURE
MTA0047B	STABILIZER BUSH	SUSPENSION	MAN	NG, NL, SL	81437220047	OD=64mm ID=24mm H=44mm	
FAWTA7530B	STABILIZER BUSH	SUSPENSION	MAN	16.281, 19.281, 19.321	81432710078, 81432710032	OD=75mm Hole ID=19mm PCD=130mm	
MTA13626B	STABILIZER BUSH	SUSPENSION	MAN	TGA, TGS, TGX	81962100630, 81437186824S	OD=43mm ID=18mm H=47mm	
MTA10058B	STABILIZER BUSH	SUSPENSION	MAN	TGS, TGX, TGA	81962100609	OD=53mm Hole ID=17mm PCD=88mm	
MTA0039B	STABILIZER BUSH	SUSPENSION	MAN	TGA, F90, F2000, M2000	81437220039	OD=67mm ID=22mm H=62mm	
MTA0053B	STABILIZER BUSH	SUSPENSION	MAN	M2000, L2000	81437220053, 85930200005	OD=56mm ID=39mm H=60mm	
MTA0057H	STABILIZER BUSH	SUSPENSION	MAN	F90, F2000	81437040057	OD=67mm ID=44mm H=60mm  <b>One Half Only</b>	
MTA0059B	STABILIZER BUSH	SUSPENSION	MAN	F2000, M2000, L2000, F90	81437220059	OD=50mm ID=16mm H=47mm	
MTA0060H	STABILIZER BUSH	SUSPENSION	MAN	F90, L2000	81437040060	OD=77mm ID=55mm H=60mm  <b>One Half Only</b>	
MTA0061H	STABILIZER BUSH	SUSPENSION	MAN	F90, F2000, TGA, TGS, TGX	81437040061, 81437220020	OD=78mm ID=60mm H=60mm  <b>One Half Only</b>	











TC CODE	DESCRIPTION	GROUP	MAKE	MODEL	OE REFERENCE	REMARK	PICTURE
MTA0063B	STABILIZER BUSH	SUSPENSION	MAN	F2000, M2000, F90	81437220063, 81437220082	OD=68mm ID=22mm H=62mm	
MTA0068H	STABILIZER BUSH	SUSPENSION	MAN	TGA, TGM	81437220068, 81437220069, 81437220080	OD=84mm ID=50mm H=72mm	
MTA0074H	STABILIZER BUSH	SUSPENSION	MAN	F2000, M2000	81437040074	OD=64mm ID=45mm H=51mm	
MTA0080B	STABILIZER BUSH	SUSPENSION	MAN	F90, F2000	81432710080	OD=65mm ID=15mm PCD=100mm	
MTA0081B	STABILIZER BUSH	SUSPENSION	MAN	F90, F2000	81432710081	OD=93mm ID=56mm H=70mm  <b>One Half Only</b>	
MTA0083H	STABILIZER BUSH	SUSPENSION	MAN	TGA, TGS, TGX, TGM	81437220083	OD=88mm ID=60mm H=60mm	
MTA0450B	STABILIZER BUSH	SUSPENSION	MAN	F2000, F90	81962100450	OD=47mm ID=16mm H=47mm	
MTA0618B	STABILIZER BUSH	SUSPENSION	MAN	TGS, TGX, TGA	81962100618	OD=47mm ID=18mm H=47mm	
MTA7248B	STABILIZER BUSH	SUSPENSION	MAN	NM	81962100063	OD=34.5mm ID=16mm H=43mm	
MTA7436B	STABILIZER BUSH	SUSPENSION	MAN	M90	81432710008, 81432710029	OD=45mm ID=16mm H=42mm	

TC CODE	DESCRIPTION	GROUP	MAKE	MODEL	OE REFERENCE	REMARK	PICTURE
MTA7512B	STABILIZER BUSH	SUSPENSION	MAN	F90, F2000	81432710083, 81432710046, 81432710079	OD=75mm Hole ID=21mm PCD=125mm	
MTA7573B	STABILIZER BUSH	SUSPENSION	MAN	M90	81437040025	OD=80mm ID=55mm H=80mm	
MTA7574B	STABILIZER BUSH	SUSPENSION	MAN	M90, M2000	81437040029	OD=71mm ID=46mm H=80mm	
MTA7702B	STABILIZER BUSH	SUSPENSION	MAN	F2000, M2000, F90	81437220059	OD=50mm ID=16mm H=47mm	
MTA7824B	STABILIZER BUSH	SUSPENSION	MAN	TGA, TGM	81437220068, 81437220069, 81437220080	OD=84mm ID=50mm H=72mm	
MTA7953B	STABILIZER BUSH	SUSPENSION	MAN	TGA, TGM, TGS, TGX	81437040078	OD=76mm ID=46mm H=50mm	
MTA8015B	STABILIZER BUSH	SUSPENSION	MAN	TGA, TGS, TGM	81437040079	OD=76mm ID=43mm H=50mm	
MTA8146B	STABILIZER BUSH	SUSPENSION	MAN	TGA, TGS, TGX, TGM	81437220083	OD=88mm ID=60mm H=60mm	
MTA8188B	STABILIZER BUSH	SUSPENSION	MAN	M2000, L2000	81437220052	OD=56mm ID=34mm H=60mm	
TA055B	STABILIZER BUSH	SUSPENSION	MAN	F90, TGA, F2000, F90	81432710082, 81432710027	OD=65mm Hole ID=21mm PCD=125mm	











NAMES, NUMBERS, SYMBOLS, DESCRIPTIONS LISTED IN THIS DOCUMENT ARE USED FOR REFERENCE PURPOSE ONLY AND IT IS NOT IMPLIED THAT ANY PARTS LISTED IS THE PRODUCT OF THESE MANUFACTURERS.

TC CODE	DESCRIPTION	GROUP	MAKE	MODEL	OE REFERENCE	REMARK	PICTURE
TA080B	STABILIZER BUSH	SUSPENSION	MAN	M90, M2000	81962100511	OD=47mm Hole ID=21mm PCD=101mm	
TA081B	STABILIZER BUSH	SUSPENSION	MAN	TGA, TGX, TGS	81436350003	OD=73mm Hole ID=19mm PCD=100mm	
TM267	STABILIZER BUSH	SUSPENSION	MAN	F90, F2000	81437220063, 81437220082	OD=68mm ID=22mm H=62mm	
MTA0085B	STABILIZER MOUNTING	SUSPENSION	MAN	TGX, TGA, TGS	81437220085	OD=96mm ID=24mm H=95mm	
MTA0094B	STABILIZER RUBBER	SUSPENSION	MAN	TGX, TGA, TGS	81437040094, 81437220081	OD=55mm ID=35mm H=51mm	
MTA10426B	STABILIZER RUBBER	SUSPENSION	MAN	TGX, TGA, TGS	81437040094, 81437220081	OD=55mm ID=35mm H=51mm	
MTA0021B	RUBBER BUSH	SUSPENSION	MAN	S2000	81442040020, 81442040021	OD=68mm ID=58mm H=80mm	
MTA10671A	STABILIZER ARM	SUSPENSION	MAN	TGX, TGA, TGS	81437186823, 81437185159	L=430mm OD=47mm ID=18mm H=47mm	
MTA13763A	STABILIZER ARM	SUSPENSION	MAN	TGA, TGS, TGX	81437186824	L=430mm OD=43mm ID=18mm H=47mm	
MTTB10787	TORSION BAR TO SHACKLE	SUSPENSION	MAN	TGA, TGX, TGS	81437180043	D= $\varnothing$ 70,5 d= $\varnothing$ 15 Ax= 87	

TC CODE	DESCRIPTION	GROUP	MAKE	MODEL	OE REFERENCE	REMARK	PICTURE
MTTB10788	TORSION BAR TO SHACKLE	SUSPENSION	MAN	TGA, TGX, TGS	81437180044	D= Ø70,5 d= Ø15 Ax= 87	
MANTCS6048	CAB SHOCK ABSORBER	CAB	MAN	F2000	81417226048, 81417226051, MONROE CB0092, SACHS 105855	D=Ø14 Lmin=309 Lmax=382	
MANTCS6049	CAB SHOCK ABSORBER	CAB	MAN	F2000, TGA	81417226049, 81417226052, MONROE CB0091, SACHS 105856	D=Ø14/Ø14 Lmin=242 Lmax=290	
MANTCS6058	CAB SHOCK ABSORBER	CAB	MAN	TGA	81417226058, 85417226007, 85417226013, SACHS 313184, SACHS 135200, SACHS 135199		
MTM0012	MOUNTING	CAB	MAN	M2000, L2000	85962100012, 85962100007	ID=31mm H=94mm	
MANTA6014B	REPAIR KIT	CAB	MAN	TGA, TGS, TGX	81417156014	OD=53mm ID=16mm H=58mm	
MTA7777-1K	REPAIR KIT	CAB	MAN	F2000, F90	81962100407S, 81962100362S, 81962100424S, 81962100437S, 81961010638S, 81971120844S, 81907130909S, 81907120844S	OD=84mm ID=16,5mm H=68mm	
MTA7935K	REPAIR KIT	CAB	MAN	TGA	81417156013	OD=60mm ID=16mm H=80mm	
MTA7590B	CAB BUSH	CAB	MAN	F2000, L2000, F90	81962100462, 81962100369	OD=30mm ID=14mm H=48mm	
MTA0437B	CAB MOUNTING	CAB	MAN	F2000, F90	81962100437, 81962100424	OD=70mm ID=16mm H=68mm	

TC CODE	DESCRIPTION	GROUP	MAKE	MODEL	OE REFERENCE	REMARK	PICTURE
MTM9248	MOUNTING	CAB	MAN	TGL	85960200004	OD=53mm ID=22mm H=42mm	
MANTCC6123	CAB CYLINDER	CAB	MAN	TGA, TGS, TGX	81417236029, 81417236137	D=50mm Ax=889mm	
MANTCC6124	CAB CYLINDER	CAB	MAN	TGA	83417236124, 85417236030, 81417236124	D=50mm Ax=940mm	
MTCC8200	CAB CYLINDER	CAB	MAN	F2000	83417236099, 81417236099	D=50mm Ax=470mm	
MTCC8201	CAB CYLINDER	CAB	MAN	TGA	83417236123, 81417236123, 85417236009	D=50mm Ax=900	
MTCC8316	CAB CYLINDER	CAB	MAN	F90, F2000	81417236076, 81417239076	D=50mm Ax=560mm	
MTHP8451	HAND PUMP	CAB	MAN	TGA, TGM, TGS	85417236011, 85417236020, 85417236044		
MTHP8519	HAND PUMP	CAB	MAN	F2000, M2000, F90	81417236026, 81417236059, 81417236114, 81417236103, 81417239114, 81417239059, 83417236114		
MTHP11650	HAND PUMP	CAB	MAN	TGA, TGM	85417236043		
MTCL8178	CAB LOCK	CAB	MAN	TGA, F2000, M2000	81618516023S, 81618516020, 81618516019, 81618516029, 81618516011		



TC CODE	DESCRIPTION	GROUP	MAKE	MODEL	OE REFERENCE	REMARK	PICTURE
MTCL11536	DOOR LOCK	CAB	MAN	F2000, F90	81626806095	Left	
MTCL11537	DOOR LOCK	CAB	MAN	F2000, F90	81626806096	Right	
MTPS8376	PRESSURE SPRING	CAB	MAN	26.270, 19.422, 19.423	81748200095	720 MM 220 N	
MTPR9504	PULL RIGHT	CAB	MAN	TGA	81626800132		
MTSA12879	SLACK ADJUSTER	CLUTCH & BRAKE	MAN	TGA, TGS, TGX, F2000	81506106253, 81506106263	Ø 14x145x0° Left	
MTSA12881	SLACK ADJUSTER	CLUTCH & BRAKE	MAN	TGA, TGS, TGX, F2000	81506106258, 81506106266	Ø 14x145x0° Right	
MTSA6210	SLACK ADJUSTER	CLUTCH & BRAKE	MAN	F2000, F90, M2000, TGA	81506106210, 81506106166	Ø 14x145x144° Right	
MTSA6211	SLACK ADJUSTER	CLUTCH & BRAKE	MAN	F2000, F90, M2000, TGA	81506106211, 81506106165	Ø 14x145x144° Left	
MTSA6212	SLACK ADJUSTER	CLUTCH & BRAKE	MAN	F2000, F90, L2000, M2000, M90, TGA	81506106212, 81506106154, 81506106084	Ø 14x145x339° Right	
MTSA6213	SLACK ADJUSTER	CLUTCH & BRAKE	MAN	F2000, F90, L2000, M2000, M90, TGA	81506106213, 81506106153, 81506106083	Ø 14x145x339° Left	

TC CODE	DESCRIPTION	GROUP	MAKE	MODEL	OE REFERENCE	REMARK	PICTURE
MTSA6214	SLACK ADJUSTER	CLUTCH & BRAKE	MAN	F2000, F90, M2000, M90, TGA	81506106214, 81506106176, 81506106140	Ø 14x145x101 <sup>ø</sup>  <b>Left</b>	
MTSA6215	SLACK ADJUSTER	CLUTCH & BRAKE	MAN	F2000, F90, M2000, M90, TGA	81506106215, 81506106177, 81506106139	Ø 14x145x101 <sup>ø</sup>  <b>Right</b>	
MTSA6231	SLACK ADJUSTER	CLUTCH & BRAKE	MAN	F2000, F90, M2000, M90	81506106231, 81506106081, 81506106151	Ø 14x145x75 <sup>ø</sup>  <b>Left &amp; Right</b>	
MTSA6263	SLACK ADJUSTER	CLUTCH & BRAKE	MAN	TGA	81506106263, 81506106253	Ø 14x145x0 <sup>ø</sup>  <b>Left</b>	
MTSA6264	SLACK ADJUSTER	CLUTCH & BRAKE	MAN	TGA	81506106264, 81506106256	Ø 14x145x0 <sup>ø</sup>  <b>Right</b>	
DPD087	EREN BRAKE PAD	CLUTCH & BRAKE	MAN	TGA, TGM	81508205099, 81508206030, 81508206033, 81508206056, 81508206032, 81508206055, WVA: 29087, WVA: 29105	Length=246.85mm Width=109.45mm Thickness=30mm  <b>Front &amp; Rear</b>	
DPD181	EREN BRAKE PAD	CLUTCH & BRAKE	MAN	TGA	81508205039, 81508205072, 81508205075, 81508205080, 81508206052, WVA: 29131	Length=249.45mm Width=118mm Thickness=29.5mm  <b>Front &amp; Rear</b>	
DPD253	EREN BRAKE PAD	CLUTCH & BRAKE	MAN	F2000, M2000, L2000, F90, TGA, TGM, TGS, TGL	81508206030, 81508206032, 81508206033, 81508206055, WVA: 29253	Length=247.5mm Width=107.5mm Thickness=29.5mm  <b>Front</b>	
DPD279	EREN BRAKE PAD	CLUTCH & BRAKE	MAN	TGA, TGX	81508205108, 81508206065, 81508206066, WVA: 29279	Length=217.45mm Width=107.28mm Thickness=30.5mm  <b>Front</b>	
DPD300	EREN BRAKE PAD	CLUTCH & BRAKE	MAN	TGA, TGM	81508205099, 81508206030, 81508206033, 81508206056, 81508206032, 81508206055, WVA: 29087, WVA: 29105	Length=247.5mm Width=109.5mm Thickness=29.5mm  <b>Front &amp; Rear</b>	

TC CODE	DESCRIPTION	GROUP	MAKE	MODEL	OE REFERENCE	REMARK	PICTURE
DPD301	EREN BRAKE PAD	CLUTCH & BRAKE	MAN	M2000, L2000	81508205017, 81508205035, 81508205094, 81508205098, 81508206008, WVA29094	Length=210.7mm Width=92.54mm Thickness=29.5mm  <b>Front &amp; Rear</b>	
DPD302	EREN BRAKE PAD	CLUTCH & BRAKE	MAN	TGL, L2000	81508206040, 81508206043, 81508206054, 81508206063, WVA: 29148	Length=185.17mm Width=84.3mm Thickness=34mm  <b>Front &amp; Rear</b>	
DPD497	EREN BRAKE PAD	CLUTCH & BRAKE	MAN	F2000, M2000, F90	81508205006, 81508205020, 81508205040, 81508205047, 81508205060, WVA: 29030	Length=249.45mm Width=118mm Thickness=28mm  <b>Front</b>	
DPD565	EREN BRAKE PAD	CLUTCH & BRAKE	MAN	M2000, L2000	81508205023, 81508205029, 81508206006, 81508206020, WVA: 29088	Length=175.4mm Width=84.1mm Thickness=25mm  <b>Front &amp; Rear</b>	
BSMB74/75	BRAKE SHOE	CLUTCH & BRAKE	MAN	NG, NL, SL	81502016187	160mm  <b>Cast</b>	
BSMP36CAST	BRAKE SHOE	CLUTCH & BRAKE	MAN	F2000, F90	815020161145	220mm  <b>Cast</b>	
BSMP31CAST	BRAKE SHOE	CLUTCH & BRAKE	MAN	SL	81502016098	160mm  <b>Cast</b>	
BSM9923	BRAKE SHOE	CLUTCH & BRAKE	MAN	TGA, TGS, TGX, F2000, M2000, F90	81502016114	220mm  <b>Fabricated</b>	
BSM9925	BRAKE SHOE	CLUTCH & BRAKE	MAN	F90	81502016193	180mm  <b>Fabricated</b>	
BSM9927	BRAKE SHOE	CLUTCH & BRAKE	MAN	HOCL	81502016192	160mm  <b>Fabricated</b>	

TC CODE	DESCRIPTION	GROUP	MAKE	MODEL	OE REFERENCE	REMARK	PICTURE
BSM9933	BRAKE SHOE	CLUTCH & BRAKE	MAN	TGA, TGS, TGX, F2000, M2000, F90	81502016184	180mm	
BSM9046	BRAKE SHOE	CLUTCH & BRAKE	MAN	SL	81502016098	160mm	
BSM9938	BRAKE SHOE	CLUTCH & BRAKE	MAN	LION, HOCL	81502016188	220mm <b>Cast</b>	
MTLK9502	CLUTCH LEVER REPAIR KIT	CLUTCH & BRAKE	MAN	TGA, TGL, TGM, M2000, L2000	81305606019	32.270, 26.270, 19.463	
104076-1	EATON CLUTCH	CLUTCH & BRAKE	MAN	TGA	3400700381, 9129111900-RB	Low HP 310-410	
104092-1	EATON CLUTCH	CLUTCH & BRAKE	MAN	TGA, TGX	3400700459, 9186222900-RB	High HP 430-480	
104377-1	EATON CLUTCH	CLUTCH & BRAKE	MAN	TGA	3400127401	SD Clutch <b>TWIN REPLACEMENT</b>	
104383-1	EATON CLUTCH	CLUTCH & BRAKE	MAN	F2000	3400122201	SD Clutch <b>TWIN REPLACEMENT</b>	
7003810216	HAMMER CLUTCH	CLUTCH & BRAKE	MAN	TGA	3400700381	Low HP 310-410	
7004590206	HAMMER CLUTCH	CLUTCH & BRAKE	MAN	TGA, TGX	3400700459	High HP 430-480	

NAMES, NUMBERS, SYMBOLS, DECEPTIONS LISTED IN THIS DOCUMENT ARE USED FOR REFERENCE PURPOSE ONLY AND IT IS NOT IMPLIED THAT ANY PARTS LISTED IS THE PRODUCT OF THESE MANUFACTURERS.











# MERCEDES GROUP



## INDEX

<u>GROUP</u>		<u>PAGES</u>
COOLING GROUP	94	98
ENGINE & TRANSMISSION GROUP	98	103
STEERING GROUP	103	108
SUSPENSION GROUP	108	116
CAB GROUP	116	117
CLUTCH & BRAKE GROUP	117	120

TC CODE	DESCRIPTION	GROUP	MAKE	MODEL	OE REFERENCE	REMARK	PICTURE
TF001	FAN	COOLING	MERCEDES	352	NA	OD=560mm PCD=88mm 6 Holes  <b>SERVICE EXCHANGE ONLY</b>	
TF002	FAN	COOLING	MERCEDES	366	NA	OD=510mm PCD=88mm 6 Holes  <b>SERVICE EXCHANGE ONLY</b>	
TF003	FAN	COOLING	MERCEDES	352	NA	OD=560mm PCD=88mm 6 Holes  <b>SERVICE EXCHANGE ONLY</b>	
TF004G	FAN	COOLING	MERCEDES	352	NA	OD=510mm ID=34mm PCD=60mm 6 Holes	
TF006	FAN	COOLING	MERCEDES	355	NA	OD=510mm ID=84mm PCD=102mm 6 Holes  <b>SERVICE EXCHANGE ONLY</b>	
TF007	BORGWARNER FAN	COOLING	MERCEDES	352	NA	OD=560mm PCD=88mm 6 Holes	
TF008	BORGWARNER FAN	COOLING	MERCEDES	366	NA	OD=510mm PCD=88mm 6 Holes	
TF009	BORGWARNER FAN	COOLING	MERCEDES	354	NA	OD=510mm PCD=88mm 6 Holes	
TF011	FAN	COOLING	MERCEDES	403	0012051206	OD=620mm ID=125mm PCD=146mm 6 Holes	
TF012	FAN	COOLING	MERCEDES	422, 442	0022059306	OD=680mm ID=125mm PCD=146mm 6 Holes	

TC CODE	DESCRIPTION	GROUP	MAKE	MODEL	OE REFERENCE	REMARK	PICTURE
TF013	FAN	COOLING	MERCEDES	407, 409	0022057006	OD=620mm ID=125mm PCD=146mm 6 Holes	
TF015	BORGWARNER FAN	COOLING	MERCEDES	422, 442	0022059306	OD=680mm ID=125mm PCD=146mm PCD=152mm 6 Holes  <b>PLASTIC</b>	
TF015	BORGWARNER FAN	COOLING	MERCEDES	407, 409	0022057006	OD=620mm ID=125mm PCD=146mm PCD=152mm 6 Holes  <b>PLASTIC</b>	
TVF023	BORGWARNER FAN	COOLING	MERCEDES	ATEGO	9062050606	OD=704mm PCD=152mm ID=127mm 6 Holes	
TVF023FM	FAN MARKET FAN	COOLING	MERCEDES	ATEGO	9062050606	OD=704mm PCD=152mm ID=127mm 6 Holes	
TVF027	FAN	COOLING	MERCEDES	POWERLINER, 442Ti	0032050006	OD=750mm PCD=200mm ID=180mm 6 Holes	
MBTVF13027	FAN	COOLING	MERCEDES	ACTROS, AXOR	0032050106	OD=750mm PCD=200mm ID=180mm 6 Holes	
TVF806	BORGWARNER FAN	COOLING	MERCEDES	ATEGO	9062050806	OD=600mm PCD=152mm ID=127mm 6 Holes	
TVF806FM	FAN MARKET FAN	COOLING	MERCEDES	ATEGO	9062050806	OD=600mm PCD=152mm ID=127mm 6 Holes	
TVF904	BORGWARNER FAN	COOLING	MERCEDES	ATEGO	9042050406	OD=600mm PCD=96mm ID=82mm 4 Holes	

NAMES, NUMBERS, SYMBOLS, DECEPTIONS LISTED IN THIS DOCUMENT ARE USED FOR REFERENCE PURPOSE ONLY AND IT IS NOT IMPLIED THAT ANY PARTS LISTED IS THE PRODUCT OF THESE MANUFACTURERS.

TC CODE	DESCRIPTION	GROUP	MAKE	MODEL	OE REFERENCE	REMARK	PICTURE
TVD001	BORGWARNER VISCOUS	COOLING	MERCEDES	POWERSTAR	NA	<b>Fan Side:</b> ID=127mm PCD=152mm 6 Holes <b>Engine Side:</b> PCD=90mm 6 Holes	
TVD022	BORGWARNER VISCOUS	COOLING	MERCEDES	ATEGO	9062000822	<b>Fan Side:</b> ID=127mm PCD=152mm 6 Holes <b>Engine Side:</b> PCD=64mm 4 Holes	
TVD022FM	FAN MARKET FAN	COOLING	MERCEDES	ATEGO	9062000822	<b>Fan Side:</b> ID=127mm PCD=152mm 6 Holes <b>Engine Side:</b> PCD=64mm 4 Holes	
TVD028	BORGWARNER VISCOUS	COOLING	MERCEDES	ACTROS	0002008422	<b>Fan Side:</b> ID=180mm PCD=200mm 6 Holes <b>Engine Side:</b> PCD=140mm 3 Holes	
TVD028FM	FAN MARKET VISCOUS	COOLING	MERCEDES	ACTROS	0002008422	<b>Fan Side:</b> ID=180mm PCD=200mm 6 Holes <b>Engine Side:</b> PCD=140mm 3 Holes	
TVD030	BORGWARNER VISCOUS	COOLING	MERCEDES	SPRINTER	0002005122	<b>Fan Side:</b> ID=115mm PCD=127mm 3 Holes	
TVD031	BORGWARNER VISCOUS	COOLING	MERCEDES	SPRINTER		<b>Fan Side:</b> ID=85mm PCD=100mm 6 Holes <b>Engine Side:</b> M24	
TVD309	BORGWARNER VISCOUS	COOLING	MERCEDES	AXOR	0002006722, 0002009022	<b>Fan Side:</b> ID=180mm PCD=200mm 6 Holes <b>Engine Side:</b> PCD=146mm 6 Holes	
TVD309FM	FAN MARKET VISCOUS	COOLING	MERCEDES	AXOR	0002006722, 0002009022	<b>Fan Side:</b> ID=180mm PCD=200mm 6 Holes <b>Engine Side:</b> PCD=146mm 6 Holes	
TVD322	BORGWARNER VISCOUS	COOLING	MERCEDES	100 BUS	6162000322		



TC CODE	DESCRIPTION	GROUP	MAKE	MODEL	OE REFERENCE	REMARK	PICTURE
TVD722	BORGWARNER VISCIOUS	COOLING	MERCEDES	AXOR	0002007722	<b>Fan Side:</b> ID=180mm PCD=200mm 6 Holes <b>Engine Side:</b> PCD=146mm 6 Holes	
TVD904	BORGWARNER VISCIOUS	COOLING	MERCEDES	OM904	9042000822	<b>Fan Side:</b> ID=82mm PCD=97mm 6 Holes <b>Engine Side:</b> PCD=63mm 4 Holes	
MBTV9623	BORGWARNER VISCIOUS	COOLING	MERCEDES	OM 646, Sprinter	0002009623	OD=430mm	
MBTV9723	BORGWARNER VISCIOUS	COOLING	MERCEDES	OM 646, Sprinter	0002009723	OD=430mm	
TD002N	DAMPER	COOLING	MERCEDES	352	3520301603	2 Pulley	
TD005SX	DAMPER	COOLING	MERCEDES	354	NA	3 Pulley	
TD006N	DAMPER	COOLING	MERCEDES	407	NA		
TD007N	DAMPER	COOLING	MERCEDES	422, 442	NA		
TH001	HUB	COOLING	MERCEDES	400 Series	4032000926	L=79mm	
TH001L	HUB	COOLING	MERCEDES	ADE, 400 Series	4042000226	L=110mm	

NAMES, NUMBERS, SYMBOLS, DECEPTIONS LISTED IN THIS DOCUMENT ARE USED FOR REFERENCE PURPOSE ONLY AND IT IS NOT IMPLIED THAT ANY PARTS LISTED IS THE PRODUCT OF THESE MANUFACTURERS.

TC CODE	DESCRIPTION	GROUP	MAKE	MODEL	OE REFERENCE	REMARK	PICTURE
TH002	HUB	COOLING	MERCEDES	ADE, 400 Series	4220351114	L=85mm	
TH003	HUB	COOLING	MERCEDES	ADE, 400 Series	4030350914	L=54mm	
TH004	HUB	COOLING	MERCEDES	ADE	NA	L=80mm	
MBTM1218	MOUNTING	ENGINE & SUSPENSION	MERCEDES	ACTROS, AXOR	9402401218	M18x1,5 M14x1,5 Ax=100x100	
MBTM7440	MOUNTING	ENGINE & SUSPENSION	MERCEDES	O309, O310, L408, L409, L508, L608	3142230012	M 16 x 1.5 d=Ø11x21 Ax=85 h=72	
MBTM7441	MOUNTING	ENGINE & SUSPENSION	MERCEDES	GM314, OM316, O309, O310, L409, L508, L608	3142230112	d=Ø11x21 Ax=112 h=72	
MBTM7442	MOUNTING	ENGINE & SUSPENSION	MERCEDES	D6, L409, L508, O309	3102420113, 3102400013	d=Ø11x14,5 Ax=130 h=74	
MBTM7907	MOUNTING	ENGINE & SUSPENSION	MERCEDES	ATEGO, AXOR	9402400817	Left	
MBTM7908	MOUNTING	ENGINE & SUSPENSION	MERCEDES	ATEGO, AXOR	9402400917	Right	
MBTM9516	MOUNTING	ENGINE & SUSPENSION	MERCEDES	ATEGO	9702400317	D=Ø102 M16x1,5	

TC CODE	DESCRIPTION	GROUP	MAKE	MODEL	OE REFERENCE	REMARK	PICTURE
TM017	MOUNTING	ENGINE & SUSPENSION	MERCEDES	O405, O407	3072400017, 3072400117	M12x1,5 Ax=150x40	
TM100	MOUNTING	ENGINE & SUSPENSION	MERCEDES	124 ENGINE	NA		
TM201	MOUNTING	ENGINE & SUSPENSION	MERCEDES	NG, O301, O402, OH, 2517, 2521, 2524	6152400318, 3812400718, 6152400418, 6152400218, 3812400618, 3862407218	M 14x1.5 M 12x1.5	
TM202	MOUNTING	ENGINE & SUSPENSION	MERCEDES	L-SERIES	3522400417, 6952407017	Left & Right Front	
TM203	MOUNTING	ENGINE & SUSPENSION	MERCEDES	L-SERIES	0002410513	Left & Right Front	
TM204	MOUNTING	ENGINE & SUSPENSION	MERCEDES	L-SERIES	3522400318, 3522400018, 3522400218	Left & Right Rear	
MBTM8445	MOUNTING	ENGINE & SUSPENSION	MERCEDES	NG-SERIES	6452400918	M18x1.5 M14x1.5 STEEL TIPE	
TM205/16	MOUNTING	ENGINE & SUSPENSION	MERCEDES	ACTROS, SK, MK, NG	6452400118, 3872400218, 3832400718, 6172400318, 6452400218, 3872400418, 6172400518	M16x1.5 M12x1.5 ALUMINIUM TIPE	
TM205/18	MOUNTING	ENGINE & SUSPENSION	MERCEDES	ACTROS, SK, MK, NG	6452400418, 6202400418, 6202400518, 6202400018, 6202400218, 6452400518, 6202400118	M 18x1.5 M 14x1.5 ALUMINIUM TIPE	
TM205A	MOUNTING	ENGINE & SUSPENSION	MERCEDES	SK, MK	6522400318, 6522400018, 6522400118	M 16x1.5 M 12x1.5	

NAMES, NUMBERS, SYMBOLS, DECEPTIONS LISTED IN THIS DOCUMENT ARE USED FOR REFERENCE PURPOSE ONLY AND IT IS NOT IMPLIED THAT ANY PARTS LISTED IS THE PRODUCT OF THESE MANUFACTURERS.

TC CODE	DESCRIPTION	GROUP	MAKE	MODEL	OE REFERENCE	REMARK	PICTURE
TM206	MOUNTING	ENGINE & SUSPENSION	MERCEDES	SK, NG	6202400717, 6202400017, 6202400217, 6202400117	d=Ø18 Ax=104 d=Ø13,5 Ax=202/102	
TM207/12	MOUNTING	ENGINE & SUSPENSION	MERCEDES	1626, 1628, 1922, 1926, 1928, 1932, 2026, 2032, 2226, 2232, 2626, 2638	3872400317, 3872400417, 3872400017	M16x1.5 M12x1.5	
TM207/16	MOUNTING	ENGINE & SUSPENSION	MERCEDES	1628 1633, 1636 1638, 1928 1933, 1936 1938, 2626 2633, 2636 2638	6202400317, 6202400517, 6202400417	M 16x1.5 M 16x1.5	
TM208	MOUNTING	ENGINE & SUSPENSION	MERCEDES	O303	3972400417, 3012403017	M12x1,5 M16x1 Ax=50x45	
TM210	MOUNTING	ENGINE & SUSPENSION	MERCEDES	L-SERIES	0002421213	Left & Right Rear	
TM211	MOUNTING	ENGINE & SUSPENSION	MERCEDES	L-SERIES	3612660184	Left & Right Rear	
TM261	MOUNTING	ENGINE & SUSPENSION	MERCEDES	ACTROS, AXOR	9412411713, 9412417713, 9412414713, 9412415713, 6342410513	M18x1,5 M14x1,5 Ax=100x200	
TM261S	MOUNTING	ENGINE & SUSPENSION	MERCEDES	TRAVEGO, TOURISMO, INTROURO	6292400217, 6292400017	M18x1,5 M14x1,5 Ax=100x200	
SH037	SILICON HOSE	ENGINE & SUSPENSION	MERCEDES			ID=15mm L=90mm	
SH038	SILICON HOSE	ENGINE & SUSPENSION	MERCEDES		N900271022024, N000000004975	ID=22mm L=90mm	









TC CODE	DESCRIPTION	GROUP	MAKE	MODEL	OE REFERENCE	REMARK	PICTURE
SH039	SILICON HOSE	ENGINE & SUSPENSION	MERCEDES		N900271050005	ID=50mm L=150mm	
SH082	SILICON HOSE	ENGINE & SUSPENSION	MERCEDES	ATEGO, AXOR	0005010082	ID=83mm L=200mm 4 HUMP	
SH282	SILICON HOSE	ENGINE & SUSPENSION	MERCEDES	SK, MK, NG	0020945282, 0010947882, 0020945982	ID=100mm L=250mm 6 HUMP	
SH382	SILICON HOSE	ENGINE & SUSPENSION	MERCEDES	AXOR	0249970382	ID=100mm L=190mm 3 HUMP	
SH582	SILICON HOSE	ENGINE & SUSPENSION	MERCEDES	ACTROS, AXOR	0020945582, 0020946682, 0020940882	ID=115mm L=210mm 5 HUMP	
SH836	SILICON HOSE	ENGINE & SUSPENSION	MERCEDES	LK	3715018082	ID=80mm L=315mm 8 HUMP	
SH837	SILICON HOSE	ENGINE & SUSPENSION	MERCEDES	LK	3715017982	ID=79mm ID=84mm L=320mm 8 HUMP	
SH838	SILICON HOSE	ENGINE & SUSPENSION	MERCEDES	ECONIC, TRAVEGO, TOURISMO	0020946982	ID=100mm L=100mm	
SH839	SILICON HOSE	ENGINE & SUSPENSION	MERCEDES	UNIMOG	0020947582, 0020943782	ID=80mm L=155mm 3 HUMP	
SH982	SILICON HOSE	ENGINE & SUSPENSION	MERCEDES	AXOR, SK, NG	0020946382, 0010947982, 0020945482	ID=100mm L=205mm 4 HUMP	

NAMES, NUMBERS, SYMBOLS, DECEPTIONS LISTED IN THIS DOCUMENT ARE USED FOR REFERENCE PURPOSE ONLY AND IT IS NOT IMPLIED THAT ANY PARTS LISTED IS THE PRODUCT OF THESE MANUFACTURERS.

TC CODE	DESCRIPTION	GROUP	MAKE	MODEL	OE REFERENCE	REMARK	PICTURE
MBSH452	SILICON HOSE	ENGINE & SUSPENSION	MERCEDES	O-SERIES	0029975452	ID=110mm L=162mm 2 HUMP	
MBTRH9658	RADIATOR HOSE	ENGINE & SUSPENSION	MERCEDES	SK, MK	6525012082	ID=65/60mm L580mm	
6PK-BELTS	V-BELT	ENGINE & SUSPENSION	MERCEDES	SPRINTER		6PK691	
8PK-BELTS	V-BELT	ENGINE & SUSPENSION	MERCEDES	ACTROS, AXOR, ATEGO		Range from: 8PK1158 Till: 8PK2604	
9PK-BELTS	V-BELT	ENGINE & SUSPENSION	MERCEDES	ACTROS, AXOR, ATEGO		Range from: 9PK1725 Till: 9PK4145	
10PK-BELTS	V-BELT	ENGINE & SUSPENSION	MERCEDES	ACTROS, AXOR, ATEGO		Range from: 10PK1350 Till: 10PK1725	
11PK-BELTS	V-BELT	ENGINE & SUSPENSION	MERCEDES	ACTROS, AXOR, ATEGO		Range from: 11PK1890 Till: 11PK2871	
12PK-BELTS	V-BELT	ENGINE & SUSPENSION	MERCEDES	ACTROS, AXOR, ATEGO		Range from: 12PK1515 Till: 12PK2490	
YP015	BELT TENSIONER	ENGINE & SUSPENSION	MERCEDES	AXOR	4572001970, 4602000970		
YP017	BELT TENSIONER	ENGINE & SUSPENSION	MERCEDES	AXOR	4572002970, 4572003170, 4572004170, 4572004370, 4572004570		

TC CODE	DESCRIPTION	GROUP	MAKE	MODEL	OE REFERENCE	REMARK	PICTURE
YP020	BELT TENSIONER	ENGINE & SUSPENSION	MERCEDES	AXOR	4572001470, 4572000270		
YP021 / 13257	BELT TENSIONER	ENGINE & SUSPENSION	MERCEDES	ATEGO, AXOR	9062002070, 9062001770		
YP022	BELT TENSIONER	ENGINE & SUSPENSION	MERCEDES	ATEGO, AXOR	9062006770, 9062005970, 9062003770, 9062004570		
YP028 / 13256	BELT TENSIONER	ENGINE & SUSPENSION	MERCEDES	ACTROS	5412003070, 5412002570, 5412000370, 5412001070, 5412001170, 5412001870, 5412001970, 5412002470		
YP047	BELT TENSIONER	ENGINE & SUSPENSION	MERCEDES	AXOR	4572004270, 4572004470, 4572003070		
YP074	BELT TENSIONER	ENGINE & SUSPENSION	MERCEDES	ACTROS	5412001570, 5412000870		
YP077	BELT TENSIONER	ENGINE & SUSPENSION	MERCEDES	ACTROS	5412000570, 4572004770, 9062003870, 9042000370, 5412000970, 4572003870, 4572002770, 4572003270		
YP112	BELT TENSIONER	ENGINE & SUSPENSION	MERCEDES	ACTROS	5412002770, 5412002370, 5412000470		
MBTS0405	DRAGLINK	STEERING	MERCEDES	O-SERIES	3754600405, 0024604605, 0024604505, 0034605005	Taper 1=23,9mm Taper 2=28,6mm Length=890mm  1=MBTS8661B 2=Crimped	
MBTS10099A	DRAGLINK	STEERING	MERCEDES	ACTROS, MK	0004609805, 0004609905	Taper 1=27mm Taper 2=30mm Length=895mm  1=TS028 2=Crimped	

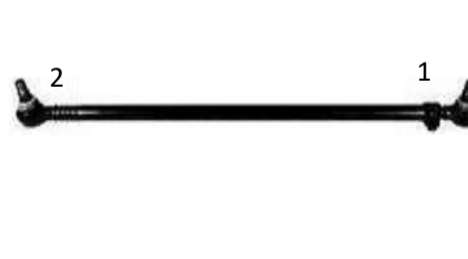
NAMES, NUMBERS, SYMBOLS, DECEPTIONS LISTED IN THIS DOCUMENT ARE USED FOR REFERENCE PURPOSE ONLY AND IT IS NOT IMPLIED THAT ANY PARTS LISTED IS THE PRODUCT OF THESE MANUFACTURERS.

TC CODE	DESCRIPTION	GROUP	MAKE	MODEL	OE REFERENCE	REMARK	PICTURE
MBTS11134A	DRAGLINK	STEERING	MERCEDES	O-SERIES	6343230216, 6343230416	Taper 1=23,5mm Taper 2=26mm Length=375mm  1=Crimped 2=Crimped	
MBTS11135A	DRAGLINK	STEERING	MERCEDES	O-SERIES	6343230316, 6343230516, 6343230116	Taper 1=23,5mm Taper 2=26mm Length=375mm  1=Crimped 2=Crimped	
MBTS4905A	DRAGLINK	STEERING	MERCEDES	ACTROS, AXOR	0024604905, 0024605005, 0034605605	Taper 1=23,9mm Taper 2=28,6mm Length=895mm  1=VOLTS0727B 2=Crimped	
MBTS8324A	DRAGLINK	STEERING	MERCEDES	ACTROS, AXOR	0024604405, 0024604305, 0034604805	Taper 1=23,9mm Taper 2=28,6mm Length=872mm  1=VOLTS0727B 2=Crimped	
MBTS8327A	DRAGLINK	STEERING	MERCEDES	O-SERIES	0024604605, 0024604505, 3754600405, 0034605005	Taper 1=23,9mm Taper 2=28,6mm Length=890mm  1=VOLTS0727B 2=Crimped	
MBTS9605A	DRAGLINK	STEERING	MERCEDES	ACTROS	0024609605, 0024609705, 0034605705	Taper 1=23,9mm Taper 2=28,6mm Length=860mm  1=VOLTS0727B 2=Crimped	
MBTS10091A	DRAGLINK	STEERING	MERCEDES	MK	0014602905, 0014603005	Taper 1=29mm Taper 2=32mm Length=840mm  1=TS036 2=Crimped	
MBTS14137A	DRAGLINK	STEERING	MERCEDES	ATEGO, AXOR	0024607705, 0024607805, 0034605105	Length=916 M28	
MBTS14156A	DRAGLINK	STEERING	MERCEDES	ATEGO	0034600705, 0034604705, 9744601105, 9744601305	Taper 1=27mm Taper 2=30mm Length=894mm  1=TS028 2=Crimped	
MBTS14244A	DRAGLINK	STEERING	MERCEDES	MK, NG	0014609705	Taper 1=27mm Taper 2=30mm Length=860mm  1=TS028 2=Crimped	









TC CODE	DESCRIPTION	GROUP	MAKE	MODEL	OE REFERENCE	REMARK	PICTURE
MBTS14611A	DRAGLINK	STEERING	MERCEDES	ACTROS, ATEGO	0014601305, 0014601405, 0024600505, 0034603205, 3754601505	Taper 1=28,8mm Taper 2=32mm Length=1095mm  1=Crimped 2=Crimped	
MBTS14622A	DRAGLINK	STEERING	MERCEDES	AXOR	3754600805, 3754601405, 3754602105, 3754602305, 3754602405	Taper 1=29mm Taper 2=32mm Length=936mm  1=TS036 23=Crimped	
TS330	DRAGLINK	STEERING	MERCEDES	SK, MK, NG	6204603705, 6204600005, 6204602005, 6204602805, 3874600405, 3874605005	Taper 1=27mm Taper 2=30mm Length=885mm  1=TS028 2=Crimped	
TS333	DRAGLINK	STEERING	MERCEDES	711, 817, 917	6734600205, 6734600405, 6734600605, 6734600805	Taper 1=19,9mm Taper 2=22mm Length=725mm  1=MBTS3135B 2=Crimped	
MBTS0403A	TIE ROD	STEERING	MERCEDES	ACTROS, ATEGO, AXOR 2	9493300403, 9493300503, 9493301403, 9493300803, 9493301903, 9493302303	Taper 1=28,8mm Taper 2=32,3mm Length=1700mm  1=TS036 2=Crimped	
MBTS1103A	TIE ROD	STEERING	MERCEDES	ACTROS, AXOR, ATEGO	9423301103, 9423300003, 9423300703, 9423300103, 9423300203, 9423302303	Taper 1=28,8mm Taper 2=32,3mm Length=1735mm  1=TS036 2=Crimped	
MBTS7003A	TIE ROD	STEERING	MERCEDES	SK, MK, NG, LK, LN2	3713307003, 3933300203, 3933300303, 3933300003, 3933300403	Taper 1=27mm Taper 2=30mm Length=1615mm  1=TS028 2=TS029	
MBTS8321A	TIE ROD	STEERING	MERCEDES	ACTROS, ATEGO	9423300403, 9423300303, 9423301603, 9423302403	Taper 1=29mm Taper 2=32mm Length=1653mm  1=TS036 2=TS035	
MBTS10104A	TIE ROD	STEERING	MERCEDES	ACTROS, AXOR, ATEGO	9413300103, 9413300203, 9413300503, 9413300003, 9413300303	Taper 1=29mm Taper 2=32mm Length=1745mm  1=TS036 2=TS035	
MBTS13919A	TIE ROD	STEERING	MERCEDES	ACTROS, ATEGO, AXOR	9493301603, 9493302403, 9493301503, 9493300703, 9493300603	Taper 1=28,8mm Taper 2=32,3mm Length=1687mm  1=TS036 2=Crimped	

NAMES, NUMBERS, SYMBOLS, DECEPTIONS LISTED IN THIS DOCUMENT ARE USED FOR REFERENCE PURPOSE ONLY AND IT IS NOT IMPLIED THAT ANY PARTS LISTED IS THE PRODUCT OF THESE MANUFACTURERS.

TC CODE	DESCRIPTION	GROUP	MAKE	MODEL	OE REFERENCE	REMARK	PICTURE
MBTS14216A	TIE ROD	STEERING	MERCEDES	ATEGO	9753300003, 9753300403, 9753301003, 9753301903	Taper 1=27mm Taper 2=30mm Length=1565  1=TS028 2=Crimped	
MBTS14385A	TIE ROD	STEERING	MERCEDES	MK, NG	3853300503, 3853300603, 3853301103, 3853301403	Taper 1=23,5mm Taper 2=26mm Length=1611mm  1=TS026 2=TS027	
MBTS14399A	TIE ROD	STEERING	MERCEDES	MK, NG	3853300203, 3853300803, 3853301603, 3853301803	Taper 1=23,5mm Taper 2=26mm Length=1635mm  1=TS026 2=Crimped	
MBTS14491A	TIE ROD	STEERING	MERCEDES	ACTROS	6253301503, 6253301603, 9423300803, 9493300203, 6253302403, 6253302503, 9493300303, 9493300903	Taper 1=29mm Taper 2=32mm Length=1615mm  1=TS036 2=TS035	
MBTS10952B	GEAR SHIFT LINK	STEERING	MERCEDES	ACTROS, ATEGO	0009967045, 0009966845	Taper 1=10mm Taper 2=10mm M14  <b>Right Hand</b>	
TS10931	GEAR SHIFT LINK	STEERING	MERCEDES	LP LPS 608, LP LPS 709, NG 1219S	0002684689, 0002686289, 3662680389	Taper 1=10mm Taper 2=10mm M12  <b>Right Hand</b>	
TS10937	GEAR SHIFT LINK	STEERING	MERCEDES	LP LPS 608, LP LPS 709, NG 1219S	0002684789, 0002686189, 3662680489	Taper 1=10mm Taper 2=10mm M12  <b>Left Hand</b>	
TS10943	GEAR SHIFT LINK	STEERING	MERCEDES		0002680181, 0002685289, 0002684889	Taper 1=10,8mm Taper 2=12mm M14  <b>Right Hand</b>	
VOLTS0727B	TIE ROD END	STEERING	MERCEDES	ACTROS, AXOR	0014603848, 0014604848, 0014609948, 0014608648	Taper 1=23,9mm Taper 2=28,6mm M30  <b>Right Hand</b>	
VOLTS0728B	TIE ROD END	STEERING	MERCEDES	ACTROS, AXOR	0014603848	Taper 1=23,9mm Taper 2=28,6mm M30  <b>Left Hand</b>	

TC CODE	DESCRIPTION	GROUP	MAKE	MODEL	OE REFERENCE	REMARK	PICTURE
MBTS1435B	TIE ROD END	STEERING	MERCEDES	LK, LN2, NG, T2, LN1, VARIO	0003301435, 0003301535, 0003307135, 0003309335, 0003309535, 0003309505, 0003382129, 0003383629	Taper 1=20mm Taper 2=22mm M28  <b>Right Hand</b>	
MBTS3135B	TIE ROD END	STEERING	MERCEDES	LK, LN2, LP, NG, O402, 808, 1513	0003303135, 0013300335, 0003308135, 0013300435	Taper 1=19,9mm Taper 2=22mm M30  <b>Right Hand</b>	
MBTS3335B	TIE ROD END	STEERING	MERCEDES	LK/LN2 NG, T2/LN1 VARIO	0003303335, 0003309635, 0023301235, 0003307235, 0003309435	Taper 1=20mm Taper 2=22mm M28  <b>Left Hand</b>	
MBTS8648B	TIE ROD END	STEERING	MERCEDES	T2/LN1, VARIO, UNIMOG	0003301335, 0003309835, 0013300035	Taper 1=20mm Taper 2=22mm M24  <b>Left Hand</b>	
MBTS8661B	TIE ROD END	STEERING	MERCEDES	ACTROS, ATEGO, AXOR	0014604248, 0014608948, 0014605048	Taper 1=23,9mm Taper 2=28,6mm M28  <b>Right Hand</b>	
MBTS9248	TIE ROD END	STEERING	MERCEDES	ACTROS SERIES, ATECO SERIES, 308, L408	0014602948'	M30x1.5 RHT L=125	
TS026	TIE ROD END	STEERING	MERCEDES	ACTROS, AXOR, ATEGO	0023301535, 0003300248, 0003303235, 0003383410, 0004608348, 0004633429, 0013300235, 0013306735	Taper 1=23,5mm Taper 2=26mm M30  <b>Right Hand</b>	
TS027	TIE ROD END	STEERING	MERCEDES	ACTROS, AXOR, ATEGO	0003300035, 0003300148, 0013308835, 3023300035, 0014604348, 0014604048, 3453307235, 3023300135	Taper 1=23,5mm Taper 2=26mm M30  <b>Left Hand</b>	
TS028	TIE ROD END	STEERING	MERCEDES	ACTROS, AXOR, ATEGO	0003305248, 0014600248, 0014607748, 0014600848, 0004600348, 0014601248, 0004602848, 0004608948	Taper 1=27mm Taper 2=30mm M30  <b>Right Hand</b>	
TS029	TIE ROD END	STEERING	MERCEDES	ACTROS, AXOR, ATEGO	0004600648, 0004601048, 0004601248, 0004603448, 0004603548, 0014600348, 0014601448, 0014601848	Taper 1=27mm Taper 2=30mm M30  <b>Left Hand</b>	

NAMES, NUMBERS, SYMBOLS, DECEPTIONS LISTED IN THIS DOCUMENT ARE USED FOR REFERENCE PURPOSE ONLY AND IT IS NOT IMPLIED THAT ANY PARTS LISTED IS THE PRODUCT OF THESE MANUFACTURERS.

TC CODE	DESCRIPTION	GROUP	MAKE	MODEL	OE REFERENCE	REMARK	PICTURE
TS035	TIE ROD END	STEERING	MERCEDES	ACTROS, AXOR, ATEGO	0004605848, 0004606948, 0014600548, 0014607948, 0004606148, 0004607148, 0014601348, 0014602548	Taper 1=29mm Taper 2=32mm M30  <b>Left Hand</b>	
TS036	TIE ROD END	STEERING	MERCEDES	ACTROS, AXOR, ATEGO	0004605748, 0004606048, 0004606848, 0004607048, 0014609648, 0014601148, 0014601748, 0014602448, 0014607548	Taper 1=29mm Taper 2=32mm M30  <b>Right Hand</b>	
TS10140B	TIE ROD END	STEERING	MERCEDES	ACTROS, AXOR, ATEGO	0004601748	Taper 1=34,3mm Taper 2=38mm M38  <b>Right Hand</b>	
MBTA9615B	STABILIZER BUSH	SUSPENSION	MERCEDES	ACTROS, AXOR	0003310017	OD=77mm ID=24mm H=96mm	
MBTA9036B	BUSH	SUSPENSION	MERCEDES	ACTROS, ATEGO, AXOR	0003504705	OD=67mm Hole ID=30mm PCD=130mm	
MBTA7431B	BUSH	SUSPENSION	MERCEDES	SK, MK, NG	0003500213S, 0003500305S, 0005861433S, 0003500505S, 0003404168S	OD=80mm Hole ID=21mm PCD=152mm	
MBTA7982B	BUSH	SUSPENSION	MERCEDES	ACTROS	0003503605	OD=108mm Hole ID=25mm PCD=152mm	
TA001B	BUSH	SUSPENSION	MERCEDES	ACTROS, AXOR	0005861135, 0003500613	OD=85mm Hole ID=21mm PCD=152mm	
TA003B	BUSH	SUSPENSION	MERCEDES	SK, NG	0003500413, 0005861235	OD=95mm Hole ID=21mm PCD=152mm	
TA018B	BUSH	SUSPENSION	MERCEDES	O530, O345	0003501513	OD=85mm Hole ID=19mm PCD=130mm	











NAMES, NUMBERS, SYMBOLS, DECEPTIONS LISTED IN THIS DOCUMENT ARE USED FOR REFERENCE PURPOSE ONLY AND IT IS NOT IMPLIED THAT ANY PARTS LISTED IS THE PRODUCT OF THESE MANUFACTURERS.

TC CODE	DESCRIPTION	GROUP	MAKE	MODEL	OE REFERENCE	REMARK	PICTURE
TA032B	BUSH	SUSPENSION	MERCEDES	ACTROS, AXOR	0003502205	OD=75mm Hole ID=25mm PCD=130mm	
TA032B/L	BUSH	SUSPENSION	MERCEDES	ACTROS, ATEGO, AXOR	0003502605	OD=75mm Hole ID=21mm PCD=152mm	
TA033B	BUSH	SUSPENSION	MERCEDES	ACTROS, AXOR	0003503505, 0003502405	OD=100mm Hole ID=25mm PCD=152mm	
TA034B	BUSH	SUSPENSION	MERCEDES	ACTROS, AXOR	0003502305, 0003504005	OD=85mm Hole ID=25mm PCD=152mm	
TA034B/L	BUSH	SUSPENSION	MERCEDES	ACTROS, AXOR	0003503105	OD=85mm Hole ID=25mm PCD=152mm	
TA058B	BUSH	SUSPENSION	MERCEDES	SK, NG	0003500113	OD=Ø108mm Hole ID=21mm PCD=152mm	
TA126B	BUSH	SUSPENSION	MERCEDES	ACTROS, AXOR	0003504805, 0003503305	OD=85mm Hole ID=23mm PCD=130mm	
TA958B	BUSH	SUSPENSION	MERCEDES	O350, O404	0003300207	OD=75mm Hole ID=19mm PCD=130mm	
VOLTA1187B	BUSH	SUSPENSION	MERCEDES	O350, O500	0003300707	OD=75mm Hole ID=17mm PCD=115mm	
TA005B	BUSH KIT	SUSPENSION	MERCEDES	1626, 2626, 2626. 2632	0003500213, 0005861433, 0003500305, 0003500505	OD=80mm H=24mm	

NAMES, NUMBERS, SYMBOLS, DECEPTIONS LISTED IN THIS DOCUMENT ARE USED FOR REFERENCE PURPOSE ONLY AND IT IS NOT IMPLIED THAT ANY PARTS LISTED IS THE PRODUCT OF THESE MANUFACTURERS.

TC CODE	DESCRIPTION	GROUP	MAKE	MODEL	OE REFERENCE	REMARK	PICTURE
TA007B	BUSH KIT	SUSPENSION	MERCEDES	L1813, 2219	3435860032, 0005861633	OD=80mm	
MBTA0805A	TORQUE ARM	SUSPENSION	MERCEDES	ACTROS, ATEGO, AXOR	9483500805, 3753500206, 9473500805, 9483501905	L=565mm Hole ID=21/21mm PCD=152/152mm  1=TA032B/L	
MBTA1305A	TORQUE ARM	SUSPENSION	MERCEDES	ACTROS, AXOR	9483501305, 9483500605, 9483501205, 9473500005	L=565mm Hole ID=21/21mm PCD=152/152mm  1=TA001B	
MBTA8051A	TORQUE ARM	SUSPENSION	MERCEDES	1626, 2626, 2626. 2632	3813500206, 3833500006	L=595mm Hole ID=21/21mm PCD=152/152mm  1=TA005B	
MBTA8065A	TORQUE ARM	SUSPENSION	MERCEDES	ACTROS, AXOR, SK, NG	6593503506, 6243500106, 6593501206	L=579mm Hole ID=21/21mm PCD=152/152mm  1=TA001B	
MBTA8305A	TORQUE ARM	SUSPENSION	MERCEDES	ACTROS, AXOR, SK, NG	6593500106, 6593502406, 3953500206	L=585mm Hole ID=21/21mm PCD=152/152mm  1=TA001B	
MBTA11805A	TORQUE ARM	SUSPENSION	MERCEDES	ACTROS, AXOR	9453500105, 9483501005, 9483502505	L=615mm Hole ID=21/21mm PCD=152/152mm  1=TA001B	
MBTA1005A	V-STAY	SUSPENSION	MERCEDES	ACTROS, AXOR	9423501005, 9423501505, 9473500105, 3753500005, 9443500005, 9473501005	L=622mm PCD=152/130/130mm Hole ID=Ø25/25/25mm  1=TA034B 2=TA032B	
MBTA2905A	V-STAY	SUSPENSION	MERCEDES	ACTROS, AXOR	9483502905	L=622mm Hole ID=25/25/25mm PCD=152/130/130mm  1=TA033B 2=TA032B	
MBTA9314A	V-STAY	SUSPENSION	MERCEDES	ACTROS, ATEGO, AXOR	9423500105, 9423501105, 9423501605, 3753500105, 9423500705	L=622mm PCD=152/130/130mm Hole ID=25/23/23mm  1=TA032B/L 2=MBTA9036B	

NAMES, NUMBERS, SYMBOLS, DECEPTIONS LISTED IN THIS DOCUMENT ARE USED FOR REFERENCE PURPOSE ONLY AND IT IS NOT IMPLIED THAT ANY PARTS LISTED IS THE PRODUCT OF THESE MANUFACTURERS.

TC CODE	DESCRIPTION	GROUP	MAKE	MODEL	OE REFERENCE	REMARK	PICTURE
TA033A	V-STAY	SUSPENSION	MERCEDES	ACTROS, AXOR	9483503005, 9443500305, 3753500205, 9473500705, 9483501105, 9443500605, 9443500505, 9483502105	L=622mm PCD=152/130/130mm Hole ID=25/25/25mm  1=TA033B 2=TA032B	
TA034A	V-STAY	SUSPENSION	MERCEDES	ACTROS, AXOR	9423500805, 9423500505, 9423501205, 3753500505, 9603500105	L=622mm PCD=152/130/130mm Hole ID=25/23/23mm  1=TA034B 2=TA126B	
TA046A	V-STAY	SUSPENSION	MERCEDES	ACTROS, AXOR	9483502205, 9483501705	L=622mm PCD=152/130/130mm Hole ID=25/23/23mm  1=MBTA7982B 2=TA126B	
UNITA9315A	V-STAY	SUSPENSION	MERCEDES	SK, NG, ACTROS, AXOR	3833500105, 6533500105, 3933505505, 3933505205, 6533530005, 3933505305, 6553500305, 3933505405, 6553500005	L=623mm PCD=152/152mm Hole ID=21/21mm  1=TA024B 2=TA001B	
MBTSA9617	SHOCK ABSORBER	SUSPENSION	MERCEDES	ACTROS, AXOR	0053239500, 0063233700, 0063236100, 3753230800, SACHS 310805, SACHS 124314, MONROE T1204	OPEN LENGTH=804 CLOSED LENGTH=479 UPPER MOUNT DIMENSION=16x50 LOWER MOUNT DIMENSION=16x50	
MBTSA9618	SHOCK ABSORBER	SUSPENSION	MERCEDES	ACTROS, AXOR	0053266400, 0053266600, 0063266800, 9583260600, 0053266600, SACHS124567, MONROET1201	OPEN LENGTH=854 CLOSED LENGTH=514 UPPER MOUNT DIMENSION=16x105 LOWER MOUNT DIMENSION=16x50	
HENTA7147B	SPRING BUSH	SUSPENSION	MERCEDES	ACTROS, AXOR	0003330217	OD=60mm PCD=132mm Hole ID=18mm	
MBTA10210B	SPRING BUSH	SUSPENSION	MERCEDES	TE, TL	9463900250	OD=155,5mm ID=32mm H=114mm	
MBTM9402	RUBBER BUFFER	SUSPENSION	MERCEDES	L-SERIES	9463900050	OD=152mm ID=31,5mm H=171mm	
MBTA1021B	SPRING EYE BUSH	SUSPENSION	MERCEDES	2524, 2527	0003220385, 0003220585	OD=60mm ID=22mm H=76mm	









NAMES, NUMBERS, SYMBOLS, DECEPTIONS LISTED IN THIS DOCUMENT ARE USED FOR REFERENCE PURPOSE ONLY AND IT IS NOT IMPLIED THAT ANY PARTS LISTED IS THE PRODUCT OF THESE MANUFACTURERS.

TC CODE	DESCRIPTION	GROUP	MAKE	MODEL	OE REFERENCE	REMARK	PICTURE
MBTA3285B	SPRING EYE BUSH	SUSPENSION	MERCEDES	ACTROS, AXOR	0003223285	OD=62mm ID=24mm H=96mm	
MBTA7581B	SPRING EYE BUSH	SUSPENSION	MERCEDES	L-SERIES	6733200150	OD=58mm ID=36mm H=96mm	
MBTA7893B	SPRING EYE BUSH	SUSPENSION	MERCEDES	ATEGO	9743200244, 9743200344, 3753200344	OD= 62mm ID=22mm H=96mm	
MBTA7895B	SPRING EYE BUSH	SUSPENSION	MERCEDES	ATEGO	9743200044, 3753200244, 9583200244	OD=64mm ID=22mm H=96mm	
MBTA7897B	SPRING EYE BUSH	SUSPENSION	MERCEDES	ATEGO	9703200144, 3753200744	OD=50mm ID=18mm H=96mm	
MBTSM7903	RUBBER METAL PLATE MOUNTING	SUSPENSION	MERCEDES	ATEGO	6753250584	Length=120mm Width=70mm H=12mm	
MBTSM0496	SPRING MOUNTING	SUSPENSION	MERCEDES	ACTROS, AXOR	0003250496'	d1=21x31 Ax=125 Ax=100	
MBTSM10867	SPRING MOUNTING	SUSPENSION	MERCEDES	AXOR	9473250296	d1=Ø15 d2=Ø17 Ax=170x60 L=152	
TSM001/5	SPRING MOUNTING	SUSPENSION	MERCEDES	ACTROS, AXOR	0003250896, 0003250696	A=232 B=165 H=116,5 <b>5 Rib</b>	
TSM001/7	SPRING MOUNTING	SUSPENSION	MERCEDES	ACTROS, ATEGO	0003250596, 0003250796	A=232 B=165 H=152 <b>7 Rib</b>	



TC CODE	DESCRIPTION	GROUP	MAKE	MODEL	OE REFERENCE	REMARK	PICTURE
MBTA2481B	STABILIZER BUSH	SUSPENSION	MERCEDES	ACTROS, AXOR	0003262481, 0003232981, 0003235985, 3753260181	OD=61mm ID=38,5mm H=56mm	
MBTA2681B	STABILIZER BUSH	SUSPENSION	MERCEDES	ACTROS, ATEOG, AXOR	0003262681, 0003263281, 0003263081, 3753260081	OD=66mm ID=47mm H=56mm	
MBTA4481B	STABILIZER BUSH	SUSPENSION	MERCEDES	ACTROS, AXOR	0003264481, 0003264781	OD=82mm ID=58mm H=56mm	
MBTA6285B	STABILIZER BUSH	SUSPENSION	MERCEDES	ACTROS, AXOR	0003236285, 0003237185	OD=42mm ID=35mm H=55mm	
MBTA7962B	STABILIZER BUSH	SUSPENSION	MERCEDES	ACTROS	0003265081, 3753260281	OD=77mm ID=46mm H=56mm	
MBTA8129B	STABILIZER BUSH	SUSPENSION	MERCEDES	ACTROS, AXOR	0003265181, 9603261881	OD=77mm ID=53mm H=56mm	
MBTA8443B	STABILIZER BUSH	SUSPENSION	MERCEDES	ACTROS, AXOR	0003236285, 0003237185	OD=42mm ID=35mm H=55mm	
MBTA8444B	STABILIZER BUSH	SUSPENSION	MERCEDES	MK	0003235885, 0003235385	OD=50mm ID=35mm H=56mm	
MBTA8772B	STABILIZER BUSH	SUSPENSION	MERCEDES	ATEGO	9703231585	OD=54mm ID=33mm H=47mm	
MBTA8784B	STABILIZER RUBBER	SUSPENSION	MERCEDES	ATEGO	9703231285	OD=54mm ID=25mm H=47mm	

NAMES, NUMBERS, SYMBOLS, DESCRIPTIONS LISTED IN THIS DOCUMENT ARE USED FOR REFERENCE PURPOSE ONLY AND IT IS NOT IMPLIED THAT ANY PARTS LISTED IS THE PRODUCT OF THESE MANUFACTURERS.

TC CODE	DESCRIPTION	GROUP	MAKE	MODEL	OE REFERENCE	REMARK	PICTURE
MBTA0050H	STABILIZER BUSH	SUSPENSION	MERCEDES	ACTROS, AXOR	9413260050, 3753260050	OD=110mm ID=82mm H=65mm	
MBTA7844B	STABILIZER BUSH	SUSPENSION	MERCEDES	O-SERIES	0003264081	OD=75mm ID=45mm H=60mm	
MBTA9400B	STABILIZER BUSH	SUSPENSION	MERCEDES	O-SERIES	6283220050	OD=76mm ID=45mm H=70mm	
MBTA7968H	STABILIZER BUSH	SUSPENSION	MERCEDES	O-SERIES	0019882410'	OD=75mm ID=45mm H=80/70mm	
MTA0081B	STABILIZER BUSH	SUSPENSION	MERCEDES	O-SERIES	3963230050	OD=93mm ID=56mm H=70mm  <b>One Half Only</b>	
MBTA7985B	STABILIZER BUSH	SUSPENSION	MERCEDES	ACTROS, AXOR	0003237985, 0003237585, 0003237485, 3753230585	OD=70mm ID=40mm H=36,5/46mm	
TM269	STABILIZER BUSH	SUSPENSION	MERCEDES	ACTROS, ATEGO, AXOR	0003238185	OD=80mm ID=40mm H=46mm	
TA081B	STABILIZER BUSH	SUSPENSION	MERCEDES	ACTROS, AXOR	9413230050, 3753230050	OD=73mm Hole ID=19mm PCD=100mm	
TA082B	STABILIZER BUSH	SUSPENSION	MERCEDES	ACTROS, AXOR	9423260050	OD=88mm Hole ID=20,5mm PCD=130mm	
MBTA8984B	STABILIZER BUSH	SUSPENSION	MERCEDES	SK, MK, NG	0003260650	OD=52mm ID=40mm H=25mm	

TC CODE	DESCRIPTION	GROUP	MAKE	MODEL	OE REFERENCE	REMARK	PICTURE
MBTA0028B	STABILIZER REPAIR KIT	SUSPENSION	MERCEDES	SK, MK, NG	6203200028	OD=86mm ID=46mm H=63mm	
MBTA7788B	STABILIZER REPAIR KIT	SUSPENSION	MERCEDES	SK, NK, LK	6213200428	OD=86mm ID=46mm H=63mm	
MBTA7845BK	STABILIZER REPAIR KIT	SUSPENSION	MERCEDES	SK, MK, NG	6203200628, 6193200128	OD=70mm ID=37mm H=62mm	
MBTA7940B	STABILIZER REPAIR KIT	SUSPENSION	MERCEDES	NG	6203200228, 6205860032	OD=70mm ID=37mm H=62mm	
MBTA0011A	STABILIZER ARM	SUSPENSION	MERCEDES	ACTROS, AXOR	9493230011S, 9493230116S	L=380mm  1=MBTA7985B	
MBTA0111A	STABILIZER ARM	SUSPENSION	MERCEDES	ACTROS, AXOR	9433230111S, 9433230516S	L=420mm  1=MBTA7985B	
MBTA0211A	STABILIZER ARM	SUSPENSION	MERCEDES	ACTROS, AXOR	9433230211S, 9433230616S	L=460mm  1=MBTA7985B	
MBTA0347A	STABILIZER ARM	SUSPENSION	MERCEDES	ACTROS, AXOR	9483260347S, 9433260347S	L=280mm  1=TM269	
MBTA0447A	STABILIZER ARM	SUSPENSION	MERCEDES	ACTROS, AXOR	9483260447S	L=340mm  1=TM269	
MBTA0547A	STABILIZER ARM	SUSPENSION	MERCEDES	AXOR	9483260547S	L=365mm  1=TM269	

NAMES, NUMBERS, SYMBOLS, DESCRIPTIONS LISTED IN THIS DOCUMENT ARE USED FOR REFERENCE PURPOSE ONLY AND IT IS NOT IMPLIED THAT ANY PARTS LISTED IS THE PRODUCT OF THESE MANUFACTURERS.

TC CODE	DESCRIPTION	GROUP	MAKE	MODEL	OE REFERENCE	REMARK	PICTURE
MBTA0647A	STABILIZER ARM	SUSPENSION	MERCEDES	ACTROS, AXOR	9483260647S	L=420mm  1=TM269	
MBTCS0219	CAB SHOCK ABSORBER	CAB	MERCEDES	ACTROS	9428900219, 9428906019, SACHS NEW 311189, SACHS OLD 290997, MONROE CB0090	D=Ø14/Ø14 Lmin=267 Lmax=315	
MBTCS2919	CAB SHOCK ABSORBER	CAB	MERCEDES	ACTROS	9428902919, 9428900119, MONROE CB0089, SACHS 105392	D=Ø14/Ø25 Lmin=259 Lmax=346	
MBTA7818B	BUSH	CAB	MERCEDES	ACTROS, ATEGO, AXOR	9423172012	OD=100mm ID=25mm H=120mm	
MBTA8122B	BUSH	CAB	MERCEDES	ACTROS, ATEGO, AXOR	0009921603'	OD=69mm ID=16mm H=64mm	
MBTA8192B	BUSH	CAB	MERCEDES	ACTROS, AXOR	9423171812, 9303170012	OD=96mm ID=40mm H=47mm	
MBTCC8463	CAB CYLINDER	CAB	MERCEDES	ACTROS	0025535405, 0025536605, 0025538405, 0025538805	D=Ø60 Ax=642	
MBTCC8199	CAB CYLINDER	CAB	MERCEDES	3-SERIES	0015533505, 0015531605, 0015531705, 0015539505	D=Ø42 Ax=593	
MBTCC8208	CAB CYLINDER	CAB	MERCEDES	SK, MK, NG	0015534205, 0015530905, 0005537305, 3715537005, 0005535105, 0005537205	D=Ø50 Ax=622	
MBTHP8196	HAND PUMP	CAB	MERCEDES	ATEGO, AXOR	0005535901, 0015535901, 3755530001		

TC CODE	DESCRIPTION	GROUP	MAKE	MODEL	OE REFERENCE	REMARK	PICTURE
MBTHP8198	HAND PUMP	CAB	MERCEDES	SK, MK, NG	0005537901, 3715537001, 0005536901, 0005532701, 0005532301, 0005533701, 0005536801, 0005533901		
MBTHP8319	HAND PUMP	CAB	MERCEDES	ACTROS	0005539901, 0015539901, 0015531401		
MBTHP8320	HAND PUMP	CAB	MERCEDES	ACTROS, ATEGO	0015533701		
MBTHP9418	HAND PUMP	CAB	MERCEDES	ACTROS	0015533901		
MBTPR10296	DOOR CABLE	CAB	MERCEDES	ACTROS	0007200513'	L=548mm	
MBTSA12851	SLACK ADJUSTER	CLUTCH & BRAKE	MERCEDES	ACTROS, ATEGO, AXOR	9454200038, 6194200038, 6194200238, 6234201238, 6234201438, 6524200038, 6584200238	Ø 14x145x0°  Left	
MBTSA12855	SLACK ADJUSTER	CLUTCH & BRAKE	MERCEDES	ACTROS, AXOR	9454200238, 3874200338, 6174200338, 6194200738, 6554200038, 9424200238	Ø 14x145x0°  Left	
MBTSA12859	SLACK ADJUSTER	CLUTCH & BRAKE	MERCEDES	ACTROS, AXOR	9454200338, 3874200238, 6174200438, 6194200638, 6554200138, 9424200338	Ø 14x145x0°  Right	
MBTSA12880	SLACK ADJUSTER	CLUTCH & BRAKE	MERCEDES	ACTROS, AXOR	9454200938	Ø 14x145x0°  Right	
MBTSA12882	SLACK ADJUSTER	CLUTCH & BRAKE	MERCEDES	ACTROS, AXOR	9454200438	Ø 14x145x0°  Left	

NAMES, NUMBERS, SYMBOLS, DECEPTIONS LISTED IN THIS DOCUMENT ARE USED FOR REFERENCE PURPOSE ONLY AND IT IS NOT IMPLIED THAT ANY PARTS LISTED IS THE PRODUCT OF THESE MANUFACTURERS.

TC CODE	DESCRIPTION	GROUP	MAKE	MODEL	OE REFERENCE	REMARK	PICTURE
DPD008	EREN BRAKE PAD	CLUTCH & BRAKE	MERCEDES	AXOR	0064201420, 0064205220, WVA: 29246	Length=244.3mm Width=113.92mm Thickness=29.5mm  <b>Front</b>	
DPD009	EREN BRAKE PAD	CLUTCH & BRAKE	MERCEDES	AXOR	0064201520, 0064205320, WVA: 29244	Length=207.3mm Width=113.92mm Thickness=29.5mm  <b>Rear</b>	
DPD87	EREN BRAKE PAD	CLUTCH & BRAKE	MERCEDES	AXOR, ATEGO, ACTROS	0044206020, 0024204920, 0044202220, 0034202220, 0004210510, WVA: 29105	Length=246.85mm Width=109.45mm Thickness=30mm  <b>Front &amp; Rear</b>	
DPD300	EREN BRAKE PAD	CLUTCH & BRAKE	MERCEDES	AXOR, ATEGO, ACTROS	0044206020, 0024204920, 0044202220, 0034202220, 0004210510, WVA: 29105, WVA: 29087	Length=247.5mm Width=109.5mm Thickness=29.5mm  <b>Front &amp; Rear</b>	
DPD301	EREN BRAKE PAD	CLUTCH & BRAKE	MERCEDES	ATEGO	0024207820, 0024207920, 0054202320, 0004210710, 0004210810, 0004215010, WVA: 29094	Length=210.7mm Width=92.54mm Thickness=29.5mm  <b>Front &amp; Rear</b>	
DPD302	EREN BRAKE PAD	CLUTCH & BRAKE	MERCEDES	ATEGO	0034201120, 0004211210, 0034206620, 0034207220, 0034207320, 0044206120, WVA29148	Length=185.17mm Width=84.3mm Thickness=34mm  <b>Front &amp; Rear</b>	
DPD497	EREN BRAKE PAD	CLUTCH & BRAKE	MERCEDES	403	0024200820, 0024205520, WVA: 29030	Length=249.45mm Width=118mm Thickness=28mm  <b>Front</b>	
DPD679	EREN BRAKE PAD	CLUTCH & BRAKE	MERCEDES		0014201520, 0014208420, 0024201520, 0024205720, 0024206620, WVA: 29835	Length=174.5mm Width=85.5mm Thickness=21.7mm  <b>Front</b>	
BSMB9923	BRAKE SHOE	CLUTCH & BRAKE	MERCEDES	SK, MK, NG	6244200219	220mm  <b>Fabricated</b>	
BSMB9925	BRAKE SHOE	CLUTCH & BRAKE	MERCEDES	ACTROS, ATEGO, AXOR	6204200219	180mm  <b>Fabricated</b>	

TC CODE	DESCRIPTION	GROUP	MAKE	MODEL	OE REFERENCE	REMARK	PICTURE
BSMB9927	BRAKE SHOE	CLUTCH & BRAKE	MERCEDES	ACTROS, ATEGO, AXOR	6594200019	160mm <b>Fabricated</b>	
BSMB9929	BRAKE SHOE	CLUTCH & BRAKE	MERCEDES	V6 / V8	3054200719	220mm <b>Fabricated</b>	
BSMB9930	BRAKE SHOE	CLUTCH & BRAKE	MERCEDES	Conecto, 345K	3054201119	160mm <b>Cast</b>	
BSMP36CAST	BRAKE SHOE	CLUTCH & BRAKE	MERCEDES	ACTROS, ATEGO, AXOR	6594200419 6594200519	220mm <b>Cast</b>	
BSMB9933	BRAKE SHOE	CLUTCH & BRAKE	MERCEDES	ACTROS, ATEGO, AXOR	3894206119	180mm <b>Cast</b>	
BSMB9936	BRAKE SHOE	CLUTCH & BRAKE	MERCEDES	LK/LN2	3894206319	160mm <b>Cast</b>	
BSMB9937	BRAKE SHOE	CLUTCH & BRAKE	MERCEDES	SK, NG, O-SERIES	3054200719S	220mm <b>Cast</b>	
104074-1	EATON CLUTCH	CLUTCH & BRAKE	MERCEDES	ACTROS	3400122801	<b>Long Bearing</b>	
1040108-1	EATON CLUTCH	CLUTCH & BRAKE	MERCEDES	ACTROS	9188-000-900-RB	<b>Short Bearing</b>	
104374-1	EATON CLUTCH	CLUTCH & BRAKE	MERCEDES	ACTROS	3400121501	SD Clutch <b>TWIN REPLACEMENT</b>	

NAMES, NUMBERS, SYMBOLS, DESCRIPTIONS LISTED IN THIS DOCUMENT ARE USED FOR REFERENCE PURPOSE ONLY AND IT IS NOT IMPLIED THAT ANY PARTS LISTED IS THE PRODUCT OF THESE MANUFACTURERS.

TC CODE	DESCRIPTION	GROUP	MAKE	MODEL	OE REFERENCE	REMARK	PICTURE
104823-1	EATON CLUTCH	CLUTCH & BRAKE	MERCEDES	AXOR	3400121301	395mm <b>No Bearing</b>	
1228010216	HAMMER CLUTCH	CLUTCH & BRAKE	MERCEDES	ACTROS	3400122801	<b>Long Bearing</b>	
7004460216	HAMMER CLUTCH	CLUTCH & BRAKE	MERCEDES	ACTROS	9188-000-900-RB	<b>Short Bearing</b>	
1215010218	HAMMER CLUTCH	CLUTCH & BRAKE	MERCEDES	ACTROS	3400121501	<b>TWIN</b>	
1213010216	HAMMER CLUTCH	CLUTCH & BRAKE	MERCEDES	ATEGO, AXOR	3400121301	395mm <b>No Bearing</b>	











# NISSAN GROUP



## INDEX

<u>GROUP</u>		<u>PAGES</u>
COOLING GROUP	122	122
ENGINE & TRANSMISSION GROUP	122	122
SUSPENSION GROUP	122	122



TC CODE	DESCRIPTION	GROUP	MAKE	MODEL	OE REFERENCE	REMARK	PICTURE
NITVF290/6	BORGWARNER FAN	COOLING	NISSAN	UD290	NA	OD=680mm PCD=172mm ID=145mm 6 Holes	
NITVF440/6	BORGWARNER FAN	COOLING	NISSAN	UD440	NA	OD=720mm PCD=172mm ID=145mm 6 Holes	
NITVF460/6	FAN	COOLING	NISSAN	UD460	NA	OD=720mm PCD=200mm ID=180mm 6 Holes	
TM218N	MOUNTING	ENGINE & TRANSMISSION	NISSAN	CW45	11328Z2004		
TM218SX	MOUNTING	ENGINE & TRANSMISSION	NISSAN	CW45	NA	Big <b>SERVICE EXCHANGE ONLY</b>	
TM219N	MOUNTING	ENGINE & TRANSMISSION	NISSAN	CW45	NA		
TM220	MOUNTING	ENGINE & TRANSMISSION	NISSAN		NA		
TA014B	BUSH	SUSPENSION	NISSAN	CW, UD	55542-00Z04	OD=105mm PCD=110mm Hole ID=19mm	
TA015B	BUSH	SUSPENSION	NISSAN	CW, UD	55542-00Z02	OD=113mm PCD=110mm Hole ID=19mm	

# PERKINS ENGINE GROUP



## INDEX

<u>GROUP</u>	<u>PAGES</u>
COOLING GROUP	124   124

TC CODE	DESCRIPTION	GROUP	MAKE	MODEL	OE REFERENCE	REMARK	PICTURE
TF027	BORGWARNER FAN	COOLING	PERKINS			OD=560mm ID=41mm PCD=63mm 4 Holes	
TF038	BORGWARNER FAN	COOLING	PERKINS			OD=765mm ID=41mm PCD=63mm 4 Holes	

# RENAULT GROUP



## INDEX

<u>GROUP</u>		<u>PAGES</u>
COOLING GROUP	126	126
ENGINE & TRANSMISSION GROUP	126	127
SUSPENSION GROUP	127	127
CLUTCH & BRAKE GROUP	127	128

TC CODE	DESCRIPTION	GROUP	MAKE	MODEL	OE REFERENCE	REMARK	PICTURE
SEMTVF027	FAN	COOLING	RENAULT	MAGNUM	5010269869	OD=720mm PCD=200mm ID=180mm 6 Holes	
RENTVF5925	BORGWARNER FAN	COOLING	RENAULT	MAGNUM	5010315927	OD=700mm PCD=200mm ID=180mm 6 Holes	
TVD817	BORGWARNER VISCOUS	COOLING	RENAULT	PREMIUM	5010315817	<b>Fan Side:</b> ID180mm PCD=200mm 6 Holes <b>Engine Side:</b> 6 Holes	
YP012	FAN HUB	COOLING	RENAULT	PREMIUM, KERAX	7422719933, 7421146755		
5PK-BELTS	V-BELT	ENGINE & TRANSMISSION	RENAULT	PREMIUM, KERAX		Range from: 5PK1025 Till: 5PK1250	
6PK-BELTS	V-BELT	ENGINE & TRANSMISSION	RENAULT	PREMIUM		6PK1420	
8PK-BELTS	V-BELT	ENGINE & TRANSMISSION	RENAULT	PREMIUM, KERAX, MAGNUM		Range from: 8PK980 Till: 8PK1610	
9PK-BELTS	V-BELT	ENGINE & TRANSMISSION	RENAULT	AXOR		9PK1691	
10PK-BELTS	V-BELT	ENGINE & TRANSMISSION	RENAULT	PREMIUM, KERAX, MAGNUM		Range from: 10PK1108 Till: 10PK1720	
YP029R	BELT TENSIONER	ENGINE & TRANSMISSION	RENAULT	MAGNUM	7421422767, 7421404578, 7408149855		

TC CODE	DESCRIPTION	GROUP	MAKE	MODEL	OE REFERENCE	REMARK	PICTURE
YP030R	BELT TENSIONER	ENGINE & TRANSMISSION	RENAULT	MAGNUM	7421257889, 7403979980		
YP031R	BELT TENSIONER	ENGINE & TRANSMISSION	RENAULT	MAGNUM	7421819687, 7421422765, 7420935521, 7420739751		
YP040R	BELT TENSIONER	ENGINE & TRANSMISSION	RENAULT	MAGNUM	7421766717, 7421393207, 7421153968, 7420521447		
YP064	BELT TENSIONER	ENGINE & TRANSMISSION	RENAULT	PREMIUM, MIDLUM	7420939284		
UNITA12920A	TORQUE ARM	SUSPENSION	RENAULT	AGORA	5010207771	L=490mm Hole ID=19/19mm PCD=130/130mm  1=TA958B	
UNITA9380A	TORQUE ARM	SUSPENSION	RENAULT	IRISBUS AGORA	5010347099	L=575mm Hole ID=19/19mm PCD=130/130mm  1=TA018B	
DPD099	EREN BRAKE PAD	CLUTCH & BRAKE	RENAULT	MIDLUM, MIDLINER	5001833104, 5001857615, WVA: 29099 WVA: 29100	Length=214.9mm Width=111.65mm Thickness=25mm  <b>Front &amp; Rear</b>	
DPD142	EREN BRAKE PAD	CLUTCH & BRAKE	RENAULT	MIDLUM, 210, 220, 250, 270	5001855902, WVA: 29142	Length=204.6mm Width=99mm Thickness=29.5mm  <b>Front &amp; Rear</b>	
DPD147	EREN BRAKE PAD	CLUTCH & BRAKE	RENAULT	MIDLUM	5010598372, 5001866914, WVA: 29147	Length=210.7mm Width=93.68mm Thickness=29.5mm  <b>Front &amp; Rear</b>	
DPD159	EREN BRAKE PAD	CLUTCH & BRAKE	RENAULT		3057008000, 5001863324, WVA: 29159	Length=210.4mm Width=92.5mm Thickness=28.8mm  <b>Front &amp; Rear</b>	

NAMES, NUMBERS, SYMBOLS, DECEPTIONS LISTED IN THIS DOCUMENT ARE USED FOR REFERENCE PURPOSE ONLY AND IT IS NOT IMPLIED THAT ANY PARTS LISTED IS THE PRODUCT OF THESE MANUFACTURERS.

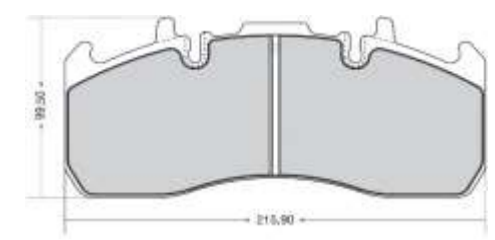
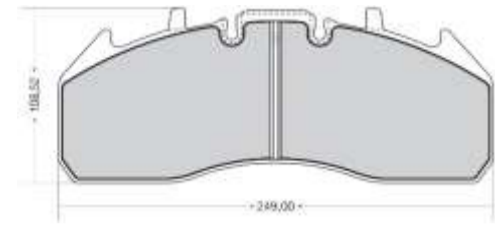
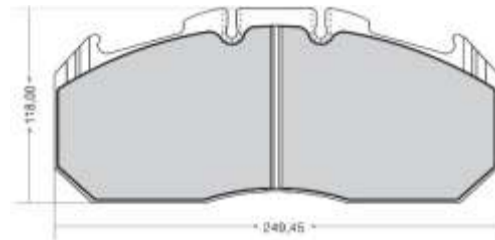
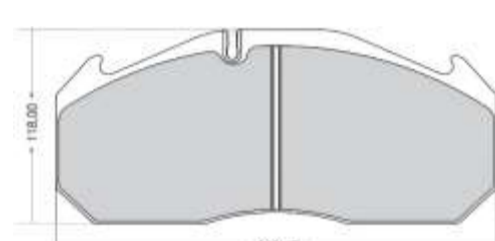
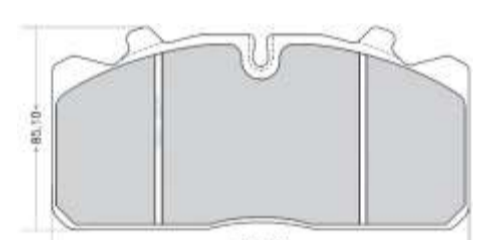
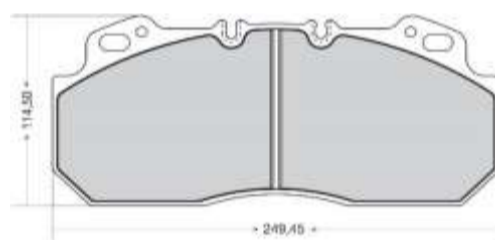
TC CODE	DESCRIPTION	GROUP	MAKE	MODEL	OE REFERENCE	REMARK	PICTURE
DPD173	EREN BRAKE PAD	CLUTCH & BRAKE	RENAULT	MIDLUM	5001864365, 7421399915, WVA: 29173	Length=215.9mm Width=99.5mm Thickness=29.25mm  <b>Front &amp; Rear</b>	
DPD174	EREN BRAKE PAD	CLUTCH & BRAKE	RENAULT	PREMIUM	7421399929, 7421496555, 5001864364, 5001864363, WVA: 29174	Length=249mm Width=108.52mm Thickness=29.5mm  <b>Front &amp; Rear</b>	
DPD181	EREN BRAKE PAD	CLUTCH & BRAKE	RENAULT	MAGNUM	5001020312, 5001855646, 5001863904, WVA: 29131	Length=249.45mm Width=118mm Thickness=29.5mm  <b>Front &amp; Rear</b>	
DPD497	EREN BRAKE PAD	CLUTCH & BRAKE	RENAULT	MAGNUM	5001834075, 5001854341, 5001854342, 5001823000, WVA: 29030	Length=249.45mm Width=118mm Thickness=28mm  <b>Front</b>	
DPD565	EREN BRAKE PAD	CLUTCH & BRAKE	RENAULT	MIDLUM	5001866951, 5010848607, WVA: 29088	Length=175.4mm Width=84.1mm Thickness=25mm  <b>Front &amp; Rear</b>	
DPD950	EREN BRAKE PAD	CLUTCH & BRAKE	RENAULT	MAGNUM, PREMIUM	5001846034, 5001831161, 5001846034, WVA: 29090	Length=249.45mm Width=114.5mm Thickness=28mm  <b>Front</b>	



# SCANIA GROUP



## INDEX











<u>GROUP</u>		<u>PAGES</u>
COOLING GROUP	130	130
ENGINE & TRANSMISSION GROUP	130	132
STEERING GROUP	132	133
SUSPENSION GROUP	133	135
CAB GROUP	135	137
CLUTCH & BRAKE GROUP	137	137

TC CODE	DESCRIPTION	GROUP	MAKE	MODEL	OE REFERENCE	REMARK	PICTURE
TVF000	BORGWARNER FAN	COOLING	SCANIA	4 - SERIES	1423891	OD=680mm PCD=152mm ID=127mm 6 Holes	
SEMTVF027	FAN	COOLING	SCANIA	P,G,R,T SERIES, 4 - SERIES	1766909	OD=750mm PCD=200mm ID=180mm 6 Holes	
SCATVF5608	BORGWARNER FAN	COOLING	SCANIA	P,G,R,T SERIES	2035608	OD=720mm PCD=214mm ID=177mm 6 Holes	
TVD891	BORGWARNER VISCOUS	COOLING	SCANIA	4 SERIES	1423891	<b>Fan Side:</b> ID=127mm PCD=152mm 6 Holes <b>Engine Side:</b> 6 Holes	
TVD909	BORGWARNER VISCOUS	COOLING	SCANIA	4 SERIES	1766909	<b>Fan Side:</b> ID=180mm PCD=200mm 6 Holes <b>Engine Side:</b> 6 Holes	
TVD995	BORGWARNER VISCOUS	COOLING	SCANIA	P,G,R,T SERIES	1856995	<b>Fan Side:</b> ID=180mm PCD=200mm 6 Holes <b>Engine Side:</b> PCD=107mm 6 Holes	
SCATVD8955	BORGWARNER VISCOUS	COOLING	SCANIA	P,G,R,T SERIES	2038955	<b>Fan Side:</b> ID=177mm PCD=214mm 6 Holes <b>Engine Side:</b> PCD=124mm 6 Holes	
SCATVD8956	BORGWARNER VISCOUS	COOLING	SCANIA	P,G,R,T SERIES	2038956	<b>Fan Side:</b> ID=177mm PCD=214mm 6 Holes <b>Engine Side:</b> PCD=124mm 4 Holes	
TV995	BORGWARNER VISCOUS & FAN COMPLETE	COOLING	SCANIA	P,G,R,T SERIES	1856995	OD=750mm	
SCATM11760	MOUNTING	ENGINE & TRANSMISSION	SCANIA	P,G,R,T SERIES	1921972, 1782203, 1779609, 1469287	L=271mm W=180mm T=227mm  <b>Left &amp; Right</b>	

TC CODE	DESCRIPTION	GROUP	MAKE	MODEL	OE REFERENCE	REMARK	PICTURE
SCATM7207	MOUNTING	ENGINE & TRANSMISSION	SCANIA	3 - SERIES	137207, 332708	OD=100mm H=66mm M12x1,75	
TM237	MOUNTING	ENGINE & TRANSMISSION	SCANIA	3 - SERIES	0364833, 364833, 0278599, 278599	Left & Right Front	
TM238	MOUNTING	ENGINE & TRANSMISSION	SCANIA	4 - SERIES	1371725, 1336882	Left & Right Rear	
TM239	MOUNTING	ENGINE & TRANSMISSION	SCANIA	P,G,R,T SERIES	1475868, 1423012, 1371729	OD=110mm H=120mm	
SCASH4725	SILICON HOSE	ENGINE & TRANSMISSION	SCANIA	P,G,R,T SERIES, 4 SERIES	1522011, 1794725, 1809771, 1442579, 1358202, 1522010	ID=80mm L=182mm 5 HUMPS	
8PK-BELTS	V-BELT	ENGINE & TRANSMISSION	SCANIA	P,G,R,T SERIES		Range from: 8PK1220 Till: 8PK2380	
10PK-BELTS	V-BELT	ENGINE & TRANSMISSION	SCANIA	P,G,R,T SERIES		Range from: 10PK2020 Till: 10PK2700	
YP032	BELT TENSIONER	ENGINE & TRANSMISSION	SCANIA		1859654, 2197002, 1774651, 1545982, 1503113, 1459988, 1493670, 1371788		
YP073	BELT TENSIONER	ENGINE & TRANSMISSION	SCANIA	P,G,R,T SERIES	2197005, 1859657, 1774654, 1774650, 1753498		
YP075	BELT TENSIONER	ENGINE & TRANSMISSION	SCANIA	P,G,R,T SERIES	2197004, 1438743, 1503115, 1545984, 1774653		

NAMES, NUMBERS, SYMBOLS, DECEPTIONS LISTED IN THIS DOCUMENT ARE USED FOR REFERENCE PURPOSE ONLY AND IT IS NOT IMPLIED THAT ANY PARTS LISTED IS THE PRODUCT OF THESE MANUFACTURERS.

TC CODE	DESCRIPTION	GROUP	MAKE	MODEL	OE REFERENCE	REMARK	PICTURE
YP095	BELT TENSIONER	ENGINE & TRANSMISSION	SCANIA	P,G,R,T SERIES	2334403, 2191989, 1870551		
YP111	BELT TENSIONER	ENGINE & TRANSMISSION	SCANIA	P,G,R,T SERIES	2197001, 1859653		
SCATS10130A	DRAGLINK	STEERING	SCANIA	4 SERIES BUS	1789082, 483527, 1455327, 1751418, 1928859	Taper 1=23,5mm Taper 2=26mm Length=284mm	
SCATS11553A	DRAGLINK	STEERING	SCANIA	3 - SERIES	1304571, 381339	Taper 1=27mm Taper 2=30mm Length=920mm  1=TS028 2=Crimped	
SCATS10127A	TIE ROD	STEERING	SCANIA	P,G,R,T SERIES, 4 SERIES	1361413, 1395614, 1734019, 1897333, 2040254	Taper 1=27mm Taper 2=30mm Length=1743mm  1=MTS11563B 2=Crimped	
SCATS11556A	TIE ROD	STEERING	SCANIA	P,G,R,T SERIES, 3 - SERIES, 4 - SERIES	1378435, 311847, 395350, 1734020, 301639, 2028998	Taper 1=27mm Taper 2=30mm Length=1736mm  1=TS028 2=TS029	
MTS11563B	TIE ROD END	STEERING	SCANIA	P,G,R,T SERIES, 4 - SERIES	1357674, 1738379	Taper 1=27mm Taper 2=30mm M30  <b>Right Hand</b>	
TS026	TIE ROD END	STEERING	SCANIA	P,G,R,T SERIES, 3 - SERIES, 4 - SERIES	1324857,	Taper 1=23,5mm Taper 2=26mm M30  <b>Right Hand</b>	
TS028	TIE ROD END	STEERING	SCANIA	P,G,R,T SERIES, 3 - SERIES, 4 - SERIES	1738381, 283784, 395010, 1767328, 1914427	Taper 1=27mm Taper 2=30mm M30  <b>Right Hand</b>	
TS029	TIE ROD END	STEERING	SCANIA	P,G,R,T SERIES, 3 - SERIES, 4 - SERIES	1358792, 283783, 1738380, 395009, 1914426	Taper 1=27mm Taper 2=30mm M30  <b>Left Hand</b>	

TC CODE	DESCRIPTION	GROUP	MAKE	MODEL	OE REFERENCE	REMARK	PICTURE
TS10931	GEAR SHIFT LINK	STEERING	SCANIA	4 SERIES	1384898, 305320, 371452, 527056, 525733, 523744	Taper 1=10mm Taper 2=10mm M12  <b>Right Hand</b>	
TS10937	GEAR SHIFT LINK	STEERING	SCANIA	4 SERIES	1384897, 305319, 371451, 523743, 525732, 527055	Taper 1=10mm Taper 2=10mm M12  <b>Left Hand</b>	
MTA6119B	BUSH	SUSPENSION	SCANIA	P,G,R,T SERIES	1515981	OD=75mm Hole ID=19mm PCD=115mm	
SCATA0800B	BUSH	SUSPENSION	SCANIA	P,G,R,T SERIES, 4 - SERIES	550800	OD=67mm Hole ID=17mm PCD=100mm	
SCATA10240B	BUSH	SUSPENSION	SCANIA	4 - SERIES	1386753	OD=91mm Hole ID=17mm PCD=115mm	
VOLTA1187B	BUSH	SUSPENSION	SCANIA	P,G,R,T SERIES, 3 - SERIES, 4 - SERIES	0550806, 639370, 5508064, 550806, 0609370, 0639370, 1104334, 1953249	OD=75mm Hole ID=17mm PCD=115mm	
VOLTA5988B	BUSH	SUSPENSION	SCANIA	3 - SERIES	639319, 550812	OD=67mm Hole ID=17mm PCD=100mm	
SCATA8347A	TORQUE ARM	SUSPENSION	SCANIA	P,G,R,T SERIES, 4 - SERIES	1428347	L=568mm Hole ID=17/17mm PCD=115/115mm  1=SCATA0800B	
SCATA9387A	TORQUE ARM	SUSPENSION	SCANIA	P,G,R,T SERIES, 4 - SERIES	1499478, 1485760, 1722750	L=616,5mm Hole ID=19/19mm PCD=115/115mm  1=MTA6119B	
SCATA9388A	TORQUE ARM	SUSPENSION	SCANIA	P,G,R,T SERIES, 4 - SERIES	1722746, 1499474	L=568mm Hole ID=19/19mm PCD=115/115mm  1=MTA6119B	

NAMES, NUMBERS, SYMBOLS, DESCRIPTIONS LISTED IN THIS DOCUMENT ARE USED FOR REFERENCE PURPOSE ONLY AND IT IS NOT IMPLIED THAT ANY PARTS LISTED IS THE PRODUCT OF THESE MANUFACTURERS.

TC CODE	DESCRIPTION	GROUP	MAKE	MODEL	OE REFERENCE	REMARK	PICTURE
SCATA10840A	V-STAY	SUSPENSION	SCANIA	P,G,R,T SERIES	1440028, 1722582	L=613,5mm Hole ID=25/19/19mm PCD=152/115/115mm  1=TA034B 2=10839	
SCATSA11485	SHOCK ABSORBER	SUSPENSION	SCANIA	4 - SERIES	1502472, 1502474, 1502470, 1502471	OD=44,65mm Min Length=242mm Max Length=342mm	
SCATA7921B	SPRING EYE BUSH	SUSPENSION	SCANIA	P,G,R,T SERIES, 3 - SERIES, 4 - SERIES	1362710, 255669, 445589	OD=65mm ID=30mm H=122mm	
SCATA8266B	SPRING EYE BUSH	SUSPENSION	SCANIA	P,G,R,T SERIES, 3 - SERIES, 4 - SERIES	128680	OD=36mm H=90mm M28x4	
SCATA8267B	SPRING EYE BUSH	SUSPENSION	SCANIA	P,G,R,T SERIES, 3 - SERIES, 4 - SERIES	135036	OD=46mm H=90mm M36x4	
SCATSB8262	SPRING BOLT	SUSPENSION	SCANIA	P,G,R,T SERIES, 3 - SERIES, 4 - SERIES	355147, 135035	M36x4 H=168,5mm	
SCATSB8265	SPRING BOLT	SUSPENSION	SCANIA	P,G,R,T SERIES, 3 - SERIES, 4 - SERIES	355145, 128681	M28x4 H=166,5mm	
SCATSB8268	SPRING BOLT	SUSPENSION	SCANIA	P,G,R,T SERIES, 3 - SERIES, 4 - SERIES	1364140	M36x4 H=168,5mm	
SCATA9032B	RUBBER BUSH	SUSPENSION	SCANIA	P,G,R,T SERIES, 4 - SERIES	1516496	OD=46,5mm ID=16mm H=24mm	
MTA0081B	STABILIZER BUSH	SUSPENSION	SCANIA	P,G,R,T SERIES, 3 - SERIES, 4 - SERIES	2521481	OD=93mm ID=56mm H=70mm  <b>One Half Only</b>	

TC CODE	DESCRIPTION	GROUP	MAKE	MODEL	OE REFERENCE	REMARK	PICTURE
SCATA9132B	STABILIZER REPAIR KIT	SUSPENSION	SCANIA	P,G,R,T SERIES, 4 - SERIES	228483S	OD=71mm ID=50mm H=103mm	
SCATA9059B	STABILIZER MOUNTING	SUSPENSION	SCANIA	P,G,R,T SERIES, 4 - SERIES	1477867, 1429110, 310808	OD=57mm ID=20mm H=30mm	
SCATCS8155	CAB SHOCK ABSORBER	CAB	SCANIA	4 - SERIES	1349844, 1382826, 1382827, 1382829, 1424229, SACHS 105873, SACHS 290989	M12x1,75 M16 x 2 Lmin = 327 Lmax = 420	
SCATCS8157	CAB SHOCK ABSORBER	CAB	SCANIA	P,G,R,T SERIES, 4 SERIES	1381903, 1381919, 1397395, 1485852, 1397399, MONROE CB0010+CB0030	Lmin = 278 Lmax = 369	
SCATCS8158	CAB SHOCK ABSORBER	CAB	SCANIA	P,G,R,T SERIES, 4 SERIES	1381905, 1476415, 1397397, 1397398 / 1381919, MONROE CB0009 + CB0030	Lmin = 325 Lmax = 427	
SCATCS8356	CAB SHOCK ABSORBER	CAB	SCANIA	P,G,R,T SERIES	1502471, 1502468	D=Ø44 L=275	
SCATA8251B	STABILIZER BUSH	CAB	SCANIA	3 - SERIES	0384595	OD=60mm H=41mm M8x1,25	
SCATA10841B	REPAIR KIT	CAB	SCANIA	P,G,R,T SERIES, 4 - SERIES	1768270S, 1377562S1, 1385170S1, 1381893S1, 1349810S	OD=60mm ID=16mm H=80mm	
SCATA8314B	REPAIR KIT	CAB	SCANIA	4 - SERIES	1377562S, 1385170S, 1381893S	OD=60mm ID=16mm H=80mm	
SCATA8315B	REPAIR KIT	CAB	SCANIA	P,G,R,T SERIES, 4 - SERIES	1343134S, 1343135S, 1481245S, 1894408S	OD=63mm ID=21mm H=20mm	

NAMES, NUMBERS, SYMBOLS, DECEPTIONS LISTED IN THIS DOCUMENT ARE USED FOR REFERENCE PURPOSE ONLY AND IT IS NOT IMPLIED THAT ANY PARTS LISTED IS THE PRODUCT OF THESE MANUFACTURERS.

TC CODE	DESCRIPTION	GROUP	MAKE	MODEL	OE REFERENCE	REMARK	PICTURE
SCATA8332-1B	REPAIR KIT	CAB	SCANIA	P,G,R,T SERIES, 4 - SERIES	1375299S, 1768269S	D=Ø36 M16x2 h=67,5	
SCATA8347B	CAB BELLOW JOINT	CAB	SCANIA	P,G,R,T SERIES, 4 - SERIES	1744210, 1504160, 1443114, 1364293	d=Ø16 h=81	
SCATA8348B	CAB BELLOW JOINT	CAB	SCANIA	P,G,R,T SERIES, 4 - SERIES	1744211, 1426202	d=Ø16 h=120	
SCATA8351B	CAB BELLOW JOINT REPAI KIT	CAB	SCANIA	P,G,R,T SERIES, 4 - SERIES	1744210S1, 1504160S1, 1443114S1, 1364293S1, 1459188S, 1343149S, 1780108S	d=Ø16 h=81	
SCATA8352B	CAB BELLOW JOINT REPAI KIT	CAB	SCANIA	P,G,R,T SERIES, 4 - SERIES	1744211S1, 1426202S1, 1459188S1, 1343149S1, 1780108S1	d=Ø16 h=120	
TM271	CAB BUSH	CAB	SCANIA	P,G,R,T SERIES, 4 - SERIES	1377562	OD=60mm ID=16mm H=80mm	
SCATM13792	CAB MOUNTING	CAB	SCANIA	P,G,R,T SERIES, 4 - SERIES	1343100	OD=87mm ID=12,5mm H=58mm	
SCATM8338	MOUNTING	CAB	SCANIA	P,G,R,T SERIES, 4 SERIES	1349810, 1899632	OD=40mm H=32mm M8x1,25	
SCATM8339	MOUNTING	CAB	SCANIA	4 - SERIES	1349805, 1923654	OD=55mm H=45mm M8x1,25	
SCATCC9426	CAB CYLINDER	CAB	SCANIA	P,G,R,T SERIES	1720924, 1477878		



TC CODE	DESCRIPTION	GROUP	MAKE	MODEL	OE REFERENCE	REMARK	PICTURE
SCATCC11644	CAB CYLINDER	CAB	SCANIA	P,G,R,T SERIES, 4 - SERIES	1720927		
SCATCC8461	CAB CYLINDER	CAB	SCANIA	P,G,R,T SERIES, 4 - SERIES	1549738, 1517324, 1575102, 575205, 1575163, 1575161, 575102, 1575205	D=Ø60 Ax=648	
SCATHP8458	HAND PUMP	CAB	SCANIA	P,G,R,T SERIES, 4 - SERIES	1549740		
SCATHP8990	HAND PUMP	CAB	SCANIA	P,G,R,T SERIES, 4 - SERIES	1549741, 1477877		
DPD011	EREN BRAKE PAD	CLUTCH & BRAKE	SCANIA		2114543, WVA: 29211	Length=216mm Width=113.25mm Thickness=29.5mm  <b>Rear</b>	
D143	EREN BRAKE PAD	CLUTCH & BRAKE	SCANIA	4 - SERIES	725857, WVA: 29143	Length=247.6mm Width=108.3mm Thickness=29.5mm  <b>Rear</b>	
DPD300	EREN BRAKE PAD	CLUTCH & BRAKE	SCANIA	P,G,R,T SERIES, 4 - SERIES	1390428, 1415153, 1444125, 1521979, 1527633, 1734529, WVA: 29087, WVA: 29105	Length=247.5mm Width=109.5mm Thickness=29.5mm  <b>Front &amp; Rear</b>	
BSSV42	BRAKE SHOE	CLUTCH & BRAKE	SCANIA	P,G,R,T SERIES, 3 - SERIES, 4 - SERIES	1104544, 1104548	203mm  <b>Cast</b>	
104065-1CL	EATON CLUTCH	CLUTCH & BRAKE	SCANIA	4 SERIES		<07-2003	
104071-1	EATON CLUTCH	CLUTCH & BRAKE	SCANIA	4 SERIES	9137-000-900-RB 3400700354	08-2003>	

NAMES, NUMBERS, SYMBOLS, DECEPTIONS LISTED IN THIS DOCUMENT ARE USED FOR REFERENCE PURPOSE ONLY AND IT IS NOT IMPLIED THAT ANY PARTS LISTED IS THE PRODUCT OF THESE MANUFACTURERS.

# TATA GROUP



## INDEX

<u>GROUP</u>		<u>PAGES</u>
COOLING GROUP	139	139
SUSPENSION GROUP	139	139





TC CODE	DESCRIPTION	GROUP	MAKE	MODEL	OE REFERENCE	REMARK	PICTURE
TF036	BORGWARNER FAN	COOLING	TATA	NOVUS	NA	OD=720mm ID=127mm PCD=152mm 6 Holes	
TF016	BORGWARNER FAN	COOLING	TATA	1518	NA	OD=560mm ID=82mm PCD=97mm 4 Holes	
TF016FM	FAN MARKET FAN	COOLING	TATA	1518	NA	OD=560mm ID=82mm PCD=97mm 4 Holes	
TVD039	BORGWARNER VISCOUS	COOLING	TATA	NOVUS	NA	<b>Fan Side:</b> ID=127mm PCD=152mm 6 Holes <b>Engine Side:</b> M30	
TVD039FM	FAN MARKET VISCOUS	COOLING	TATA	NOVUS	NA	<b>Fan Side:</b> ID=127mm PCD=152mm 6 Holes <b>Engine Side:</b> M30	
TVD042	BORGWARNER VISCOUS	COOLING	TATA	1518	NA	<b>Fan Side:</b> ID=82mm PCD=97mm 6 Holes <b>Engine Side:</b> 4 Holes	
TA014B	BUSH	SUSPENSION	TATA	NOVUS	NA	OD=105mm PCD=110mm Hole ID=19mm	

# TEREX GROUP



## INDEX

<u>GROUP</u>		<u>PAGES</u>
COOLING GROUP	141	141
ENGINE & TRANSMISSION GROUP	141	141
SUSPENSION GROUP	141	141











TC CODE	DESCRIPTION	GROUP	MAKE	MODEL	OE REFERENCE	REMARK	PICTURE
TVF284	BORGWARNER FAN	COOLING	TEREX	TA	NA	OD=820mm PCD=152mm ID=127 6 Holes	
TC017	COUPLING	ENGINE & TRANSMISSION	TEREX	TA	NA		
TPB305	BUSH	SUSPENSION	TEREX	TA30, TA35, TA40	15268490	OD=90mm PCD=130mm Hole ID=19mm	
TPM176	SPRING MOUNTING	SUSPENSION	TEREX	TA30, TA35, TA40	15250584, 15346213, 15358397		

# VOLVO GROUP



## INDEX









<u>GROUP</u>		<u>PAGES</u>
COOLING GROUP	143	144
ENGINE & TRANSMISSION GROUP	145	148
STEERING GROUP	148	150
SUSPENSION GROUP	150	155
CAB GROUP	156	157
CLUTCH & BRAKE GROUP	157	158

TC CODE	DESCRIPTION	GROUP	MAKE	MODEL	OE REFERENCE	REMARK	PICTURE
TVF239	BORGWARNER FAN	COOLING	VOLVO	FM9, FM12	20450239	OD=680mm PCD=152mm ID=127mm 6 Holes	
TVF240	BORGWARNER FAN	COOLING	VOLVO	FH12	20450240	OD=750mm PCD=152mm ID=127mm 6 Holes	
TVF371	BORGWARNER FAN	COOLING	VOLVO	FH	21382371	OD=680mm PCD=215mm ID=178mm 6 Holes	
SEMTVF027	FAN	COOLING	VOLVO	FH440	21037403	OD=750mm PCD=200mm ID=180mm 6 Holes	
TVD036	BORGWARNER VISCOUS	COOLING	VOLVO			<b>Fan Side:</b> ID=127mm PCD=152mm 6 holes <b>Engine Side:</b> PCD=112mm 4 Holes	
TVD240	BORGWARNER VISCOUS	COOLING	VOLVO	FH12	20450240, 85000178	<b>Fan Side:</b> ID=127mm PCD=152mm 6 holes <b>Engine Side:</b> PCD=112mm 4 Holes	
TVD240FM	FAN MARKET VISCOUS	COOLING	VOLVO	FH12	20450240, 85000178	<b>Fan Side:</b> ID=127mm PCD=152mm 6 holes <b>Engine Side:</b> PCD=112mm 4 Holes	
TVD371	BORGWARNER VISCOUS	COOLING	VOLVO	FH	21382371	<b>Fan Side:</b> ID=177mm PCD=214mm 6 holes <b>Engine Side:</b> PCD=112mm 4 Holes	
TVD403	BORGWARNER VISCOUS	COOLING	VOLVO	FH	21037403, 20981227, 20805997, 20517753, 85000818, 85000739, 85000586, 85000282	<b>Fan Side:</b> ID=180mm PCD=200mm 6 holes <b>Engine Side:</b> PCD=112mm 4 Holes	
TVD403FM	FAN MARKET VISCOUS	COOLING	VOLVO	FH	21037403, 20981227, 20805997, 20517753, 85000818, 85000739, 85000586, 85000282	<b>Fan Side:</b> ID=180mm PCD=200mm 6 holes <b>Engine Side:</b> PCD=112mm 4 Holes	











NAMES, NUMBERS, SYMBOLS, DECEPTIONS LISTED IN THIS DOCUMENT ARE USED FOR REFERENCE PURPOSE ONLY AND IT IS NOT IMPLIED THAT ANY PARTS LISTED IS THE PRODUCT OF THESE MANUFACTURERS.

TC CODE	DESCRIPTION	GROUP	MAKE	MODEL	OE REFERENCE	REMARK	PICTURE
TVD039	BORGWARNER VISCOUS	COOLING	VOLVO	FL	8149470	<b>Fan Side:</b> ID=127mm PCD=152mm 6 Holes <b>Engine Side:</b> M30	
TVD039FM	FAN MARKET VISCOUS	COOLING	VOLVO	FL	8149470	<b>Fan Side:</b> ID=127mm PCD=152mm 6 Holes <b>Engine Side:</b> M30	
TVD154	BORGWARNER VISCOUS	COOLING	VOLVO	FL	8149833, 8149654, 8113266, 8113135, 1676387, 1676290	<b>Fan Side:</b> ID=82mm PCD=97mm 4 Holes <b>Engine Side:</b> M30	
TVD154FM	FAN MARKET VISCOUS	COOLING	VOLVO	FL	8149833, 8149654, 8113266, 8113135, 1676387, 1676290	<b>Fan Side:</b> ID=82mm PCD=97mm 4 Holes <b>Engine Side:</b> M30	
TV240	BORGWARNER VISCOUS & FAN COMPLETE	COOLING	VOLVO	FM	20450239	OD=680mm	
TV240	BORGWARNER VISCOUS & FAN COMPLETE	COOLING	VOLVO	FH	20450240	OD=750mm	
TV403	BORGWARNER VISCOUS & FAN COMPLETE	COOLING	VOLVO	FH	21037403	OD=750mm	
YP009	FAN HUB	COOLING	VOLVO	FH	20810755, 2115786, 20451712, 21146740, 22031832		
YP056	FAN HUB	COOLING	VOLVO	FH, FM	3183672, 1675786		
YP071	FAN HUB	COOLING	VOLVO	FM	21146752, 21986107, 21986056		











TC CODE	DESCRIPTION	GROUP	MAKE	MODEL	OE REFERENCE	REMARK	PICTURE
TM646	MOUNTING	ENGINE & TRANSMISSION	VOLVO	FH, FM	20503551, 1622825	d=Ø13 Ax=90x210	
TM693	MOUNTING	ENGINE & TRANSMISSION	VOLVO	B12	1629614	d=Ø16 Ax=180x200	
TM693N/NG	MOUNTING	ENGINE & TRANSMISSION	VOLVO	FH, FM, FMX	20499469, 20199472	d=Ø14,5 Ax=200x180 M20x2,5	
VOLTM10961	MOUNTING	ENGINE & TRANSMISSION	VOLVO	FH, FM	20747058	OD=83mm H=38mm M=10x1,5	
VOLTM11783	MOUNTING	ENGINE & TRANSMISSION	VOLVO	FH, FM	20399981	L=261,4mm H=158mm W=211mm	
VOLTM9992	MOUNTING	ENGINE & TRANSMISSION	VOLVO	FH, FM	20399992, 20399980	L=261,4mm H=158mm W=211mm	
VOLTM3746	MOUNTING	ENGINE & TRANSMISSION	VOLVO	A25D, A25E, A25F A30D, A30E, A30F	11113746		
VOLTM14000	MOUNTING	ENGINE & TRANSMISSION	VOLVO	FH, FM	21416525, 21416526	PCD=300mm	
SH081	SILICON HOSE	ENGINE & TRANSMISSION	VOLVO	B - SERIES	1195081	ID=60mm L=160mm	
SH327	SILICON HOSE	ENGINE & TRANSMISSION	VOLVO	F - SERIES	470327	ID=76mm L=60mm	

NAMES, NUMBERS, SYMBOLS, DESCRIPTIONS LISTED IN THIS DOCUMENT ARE USED FOR REFERENCE PURPOSE ONLY AND IT IS NOT IMPLIED THAT ANY PARTS LISTED IS THE PRODUCT OF THESE MANUFACTURERS.

TC CODE	DESCRIPTION	GROUP	MAKE	MODEL	OE REFERENCE	REMARK	PICTURE
SH328	SILICON HOSE	ENGINE & TRANSMISSION	VOLVO	FH, FM, F	466328	ID=19mm L=60mm	
SH329	SILICON HOSE	ENGINE & TRANSMISSION	VOLVO	B - SERIES	3028329	ID=48mm ID=58mm L=240mm	
SH391	SILICON HOSE	ENGINE & TRANSMISSION	VOLVO	B - SERIES	1196391, 8365091	ID=50mm ID=60mm L=160mm	
SH464	SILICON HOSE	ENGINE & TRANSMISSION	VOLVO	F, B	470464	ID=57mm L=65mm	
SH576	SILICON HOSE	ENGINE & TRANSMISSION	VOLVO	B - SERIES	1195576	ID=60mm L=250mm	
SH701	SILICON HOSE	ENGINE & TRANSMISSION	VOLVO	B - SERIES	9519701	ID=58mm L=360mm	
SH800	SILICON HOSE	ENGINE & TRANSMISSION	VOLVO	FH, FM, FMX	8149800, 1665556	ID=80mm L=390mm 12 HUMP	
VOLTSH10666	SILICON HOSE	ENGINE & TRANSMISSION	VOLVO	FH, FM, FL	1676481, 20463924, 20561450, 1676491	ID=83mm L=150mm 3 Hump	
VOLTSH11829	SILICON HOSE	ENGINE & TRANSMISSION	VOLVO	FH, FM	8154602	ID=19mm ID=40mm L=380mm L=90mm	
VOLTRH11088	RADIATOR HOSE	ENGINE & TRANSMISSION	VOLVO	FH, FM	21258220, 20549855	ID=60mm ID=62mm L=420mm	

NAMES, NUMBERS, SYMBOLS, DECEPTIONS LISTED IN THIS DOCUMENT ARE USED FOR REFERENCE PURPOSE ONLY AND IT IS NOT IMPLIED THAT ANY PARTS LISTED IS THE PRODUCT OF THESE MANUFACTURERS.

TC CODE	DESCRIPTION	GROUP	MAKE	MODEL	OE REFERENCE	REMARK	PICTURE
VOLTRH8422	RADIATOR HOSE	ENGINE & TRANSMISSION	VOLVO	FH, FM	1665940	ID=60mm ID=65mm H=520mm	
5PK-BELTS	V-BELT	ENGINE & TRANSMISSION	VOLVO	B9		5PK1525	
8PK-BELTS	V-BELT	ENGINE & TRANSMISSION	VOLVO	FH, FM, FL, FMX		Range from: 8PK800 Till: 8PK2020	
10PK-BELTS	V-BELT	ENGINE & TRANSMISSION	VOLVO	FM, FH, FMX		Range from: 10PK1070 Till: 10PK2220	
YP029V	BELT TENSIONER	ENGINE & TRANSMISSION	VOLVO	FH, FM	21404578, 20966526, 21422767, 8149855, 20935523		
YP030V	BELT TENSIONER	ENGINE & TRANSMISSION	VOLVO	FH, FM	21257889, 8149879		
YP031V	BELT TENSIONER	ENGINE & TRANSMISSION	VOLVO	FH, FM	21422765, 3979979, 85013020, 20935521		
YP037	BELT TENSIONER	ENGINE & TRANSMISSION	VOLVO	FH, FM	21479276, 21260406		
YP040V	BELT TENSIONER	ENGINE & TRANSMISSION	VOLVO	FH	21766717, 21393207, 21153968		
YP065	BELT TENSIONER	ENGINE & TRANSMISSION	VOLVO	FL, FE	21500191, 20799527, 20939284		

NAMES, NUMBERS, SYMBOLS, DECEPTIONS LISTED IN THIS DOCUMENT ARE USED FOR REFERENCE PURPOSE ONLY AND IT IS NOT IMPLIED THAT ANY PARTS LISTED IS THE PRODUCT OF THESE MANUFACTURERS.

TC CODE	DESCRIPTION	GROUP	MAKE	MODEL	OE REFERENCE	REMARK	PICTURE
YP069	BELT TENSIONER	ENGINE & TRANSMISSION	VOLVO		3779087		
YP094	BELT TENSIONER	ENGINE & TRANSMISSION	VOLVO	FH	21549016, 20923200, 20700787, 20515543		
YP096	BELT TENSIONER	ENGINE & TRANSMISSION	VOLVO	FH	21631484, 20491753, 21155561		
VOLTA3063A	DRAGLINK	STEERING	VOLVO	FH, FM, FMX	20443063, 20443067, 20539988	Taper 1=24,7mm Taper 2=28,6mm Length=350mm	
VOLTS10120A	DRAGLINK	STEERING	VOLVO	FH, FM, FMX	20443061, 20443065	Taper 1=24,7mm Taper 2=28,6mm Length=435mm	
VOLTS3063A	DRAGLINK	STEERING	VOLVO	FH, FM	3173613, 3987354	Taper 1=25,5mm Taper 2=28,6mm Length=435mm	
VOLTS9668	DRAGLINK	STEERING	VOLVO	FH, FM, FMX	1629668, 20477805, 22325247	Taper 1=20mm Taper 2=22mm Length=325mm	
VOLTS11547A	DRAGLINK	STEERING	VOLVO	FH, FM	20393187, 21106952	Taper 1=23,9mm Taper 2=28,6mm Length=863mm  1=VOLTS0727B 2=Crimped	
VOLTS14106A	DRAGLINK	STEERING	VOLVO	FH, FM	1075664, 20393063, 3988701	Taper 1=23,9mm Taper 2=28,6mm Length=860mm  1=VOLTS0727B 2=Crimped	
VOLTS6892A	DRAGLINK	STEERING	VOLVO	B - SERIES	70376892	Taper 1=24,7mm Taper 2=28,6mm Length=150mm	

NAMES, NUMBERS, SYMBOLS, DECEPTIONS LISTED IN THIS DOCUMENT ARE USED FOR REFERENCE PURPOSE ONLY AND IT IS NOT IMPLIED THAT ANY PARTS LISTED IS THE PRODUCT OF THESE MANUFACTURERS.

TC CODE	DESCRIPTION	GROUP	MAKE	MODEL	OE REFERENCE	REMARK	PICTURE
VOLTS6450	TIE ROD	STEERING	VOLVO	FH, FM, FMX	3986450, 3988711, 3962343, 1628637	Taper 1=23,9mm Taper 2=28,6mm Length=1640mm  1=VOLTS0727B 2=VOLTS0728B	
MBTS1435B	TIE ROD END	STEERING	VOLVO	F, FL	1517440, 1517444, 1698191	Taper 1=20mm Taper 2=22mm M28  <b>Right Hand</b>	
MBTS3335B	TIE ROD END	STEERING	VOLVO	F, FL	1517279, 1517439, 1698190	Taper 1=20mm Taper 2=22mm M28  <b>Left Hand</b>	
MBTS8648B	TIE ROD END	STEERING	VOLVO	FL, FLC	1696920	Taper 1=20mm Taper 2=22mm M24  <b>Left Hand</b>	
TS026	TIE ROD END	STEERING	VOLVO	FH, FL, F, FM	1695690, 1697297, 1517577, 15175771	Taper 1=23,5mm Taper 2=26mm M30  <b>Right Hand</b>	
TS028	TIE ROD END	STEERING	VOLVO	FL	20742127, 20745043, 20821160, 20862494	Taper 1=27mm Taper 2=30mm M30  <b>Right Hand</b>	
TS029	TIE ROD END	STEERING	VOLVO	FL	20742129, 20821150, 20745042	Taper 1=27mm Taper 2=30mm M30  <b>Left Hand</b>	
TS10146B	TIE ROD END	STEERING	VOLVO	FH, FM	3097228, 3099529	Taper 1=23,9mm Taper 2=28,6mm M30  <b>Right Hand</b>	
VOLTS0727B	TIE ROD END	STEERING	VOLVO	FH, FM, FL, F	1505759, 1698532, 1698846, 3092472, 6884002, 1507823, 85114148, 3090727	Taper 1=23,9mm Taper 2=28,6mm M30  <b>Right Hand</b>	
VOLTS0728B	TIE ROD END	STEERING	VOLVO	FH, FM, FL, F	1507822, 366757, 3092471, 1698847, 1505758, 1698533, 6884001, 6889478	Taper 1=23,9mm Taper 2=28,6mm M30  <b>Left Hand</b>	

NAMES, NUMBERS, SYMBOLS, DESCRIPTIONS LISTED IN THIS DOCUMENT ARE USED FOR REFERENCE PURPOSE ONLY AND IT IS NOT IMPLIED THAT ANY PARTS LISTED IS THE PRODUCT OF THESE MANUFACTURERS.











TC CODE	DESCRIPTION	GROUP	MAKE	MODEL	OE REFERENCE	REMARK	PICTURE
VOLTS400	TIE ROD END	STEERING	VOLVO	F, FL	1131741, 1699400, 6889483, 1696900, 6882151	Taper 1=23,9mm Taper 2=28,6mm M52  <b>Left Hand</b>	
VOLTS401	TIE ROD END	STEERING	VOLVO	F, FL	1131742, 1696901, 6889484, 1699401, 6882152	Taper 1=23,9mm Taper 2=28,6mm M52  <b>Right Hand</b>	
TS10931	GEAR SHIFT LINK	STEERING	VOLVO	FH, FL, F	1696685, 1190131	Taper 1=10mm Taper 2=10mm M12  <b>Right Hand</b>	
TS10937	GEAR SHIFT LINK	STEERING	VOLVO	FH, FL, F	1696684, 1190132	Taper 1=10mm Taper 2=10mm M12  <b>Left Hand</b>	
TS10943	GEAR SHIFT LINK	STEERING	VOLVO	F, FL	6027074, 6853913, 1527453, 1672152	Taper 1=10,8mm Taper 2=12mm M14  <b>Right Hand</b>	
VOLTS10950B	GEAR SHIFT LINK	STEERING	VOLVO	F, FL	1527234, 1668638, 382745	Taper 1=14,4mm Taper 2=16mm M28  <b>Right Hand</b>	
VOLTS10951B	GEAR SHIFT LINK	STEERING	VOLVO	FH, FM	1668179	Taper 1=14,4mm Taper 2=16mm M16  <b>Right Hand</b>	
VOLTA5080B	BUSH	SUSPENSION	VOLVO	FH, FM	1135080	OD=91mm ID=52mm H=85mm	
MTA6119B	BUSH	SUSPENSION	VOLVO	FH, FM, FL	20547286	OD=75mm Hole ID=19mm PCD=115mm	
SCATA10240B	BUSH	SUSPENSION	VOLVO	B - SERIES	70371217	OD=91mm Hole ID=17mm PCD=115mm	

TC CODE	DESCRIPTION	GROUP	MAKE	MODEL	OE REFERENCE	REMARK	PICTURE
TA001B	BUSH	SUSPENSION	VOLVO	F, FL	274068	OD=85mm Hole ID=21mm PCD=152mm	
TPB100	BUSH	SUSPENSION	VOLVO	A35D, A35E, A35E FS, A35F FS A40D, A40E, A40E FS, A40F FS T450D	15049695, 11191362	OD=105mm PCD=152mm Hole ID=25	
VOLTA10430B	BUSH	SUSPENSION	VOLVO	B - SERIES	20702096	OD=85mm Hole ID=21mm PCD=130mm	
VOLTA1187B	BUSH	SUSPENSION	VOLVO	F, FL	271187, 11043031	OD=75mm Hole ID=17mm PCD=115mm	
VOLTA5988B	BUSH	SUSPENSION	VOLVO	FH, FM, F	275988	OD=67mm Hole ID=17mm PCD=100mm	
VOLTA8107B	BUSH	SUSPENSION	VOLVO	FH, FM	1628107	OD=91mm Hole ID=15mm PCD=145mm	
VOLTA8225B	BUSH	SUSPENSION	VOLVO	FH, FM	20840815, 3093630, 3093631	OD=85mm Hole ID=21x26mm PCD=130mm	
VOLTA8588B	BUSH	SUSPENSION	VOLVO	FH, FM, F	1598588, 3159435	OD=91mm Hole ID=14mm PCD=125mm	
VOLTA8616B	BUSH	SUSPENSION	VOLVO	FH, FM	273612	OD=95mm Hole ID=21mm PCD=130mm	
TA025B	BUSH KIT	SUSPENSION	VOLVO	FH, FM	3090712	D=90mm	

NAMES, NUMBERS, SYMBOLS, DECEPTIONS LISTED IN THIS DOCUMENT ARE USED FOR REFERENCE PURPOSE ONLY AND IT IS NOT IMPLIED THAT ANY PARTS LISTED IS THE PRODUCT OF THESE MANUFACTURERS.





TC CODE	DESCRIPTION	GROUP	MAKE	MODEL	OE REFERENCE	REMARK	PICTURE
TA025B/S	BUSH KIT	SUSPENSION	VOLVO	FH, FM	20741710	OD=72mm H=45mm M20x1,5	
VOLTA8523B	BUSH KIT	SUSPENSION	VOLVO	FH, FM, FMX	20840820	Ø90	
TA958A	TORQUE ARM	SUSPENSION	VOLVO	F, FL	1606551, 8154016	L=660mm Hole ID=21/21mm PCD=130/130mm  1=TA958B	
VOLTA1052A	TORQUE ARM	SUSPENSION	VOLVO	FH, FM, FMX, FL	21051052, 20522934	L=510mm Hole ID=21/21mm PCD=130/130mm  1=VOLTA8616B	
VOLTA8615A	TORQUE ARM	SUSPENSION	VOLVO	FH, FM, FMX, FL	21051052, 20522934	L=510mm Hole ID=21/21mm PCD=130/130mm  1=VOLTA8616B	
VOLTA3044A	TORQUE ARM	SUSPENSION	VOLVO	FH, FM	20443044	L=510mm Hole ID=17/17mm PCD=115/115mm  1=VOLTA1187B	
VOLTA5427A	TORQUE ARM	SUSPENSION	VOLVO	B, FL	1135427	L=666mm Hole ID=14/52mm PCD=125/30mm  1=VOLTA5080B 2=VOLTA8588B	
VOLTA9395A	TORQUE ARM	SUSPENSION	VOLVO	FL, FM, F, B	1589817	L=666mm Hole ID=14/14mm PCD=125/30mm  1=VOLTA8588B	
UNITA11812A	TORQUE ARM	SUSPENSION	VOLVO	IRIZAR	20816978, 24426045, 70301436, 21477187	L=510mm Hole ID=17/17mm PCD=130/130mm  1=TA958B	
UNITA9397A	TORQUE ARM	SUSPENSION	VOLVO	FL	1581527, 1607079, 8154017, 8158207, 8158206	L=660mm Hole ID=21/21mm PCD=130/130mm  1=VOLTA10430B	













TC CODE	DESCRIPTION	GROUP	MAKE	MODEL	OE REFERENCE	REMARK	PICTURE
UNITA9398A	TORQUE ARM	SUSPENSION	VOLVO	FH, FM	1626958	L=571mm Hole ID=21/21mm PCD=130/130mm  1=VOLTA10430B	
UNITA9399A	TORQUE ARM	SUSPENSION	VOLVO	F, FL	1606551, 8154016	L=660mm Hole ID=21/21mm PCD=130/130mm  1=TA958B	
TA649A	V-STAY	SUSPENSION	VOLVO	FH, FM	20392649, 1076639, 1629734, 1626896	L=671mm PCD=130/130mm Hole ID=21x26/21x26  1=TA025B 2=VOLTA8225B <b>HUB REDUCTION</b>	
TA703A	V-STAY	SUSPENSION	VOLVO	FH	20741703, 20367004, 20507262, 20741695	L=663mm PCD=115/115mm Hole ID=19/19mm  1=TA025B/S 2=MTA6119B <b>HI POINT</b>	
VOLTA10459A	V-STAY	SUSPENSION	VOLVO	FH, FM, FMX	21295227	L=671mm Hole ID=23/23mm PCD=130/130mm  1=VOLTA8523B 2=TA126B	
VOLTA9321A	V-STAY	SUSPENSION	VOLVO	FH, FM	3173292, 20556491	L=677mm PCD=30-145/30-145mm Hole ID=15/15mm  1=7841 2=VOLTA8107B	
VOLTA8021B	BUSH	SUSPENSION	VOLVO	B - SERIES	70308561	OD=70mm ID=16mm H=82mm	
VOLTA8526B	STABILIZER BUSH	SUSPENSION	VOLVO	FH, FM	20533294	OD=52mm ID=20mm H=110mm	
VOLTA10191B	SPRING BUSH	SUSPENSION	VOLVO	FH, FM, FL	20959115	OD=51mm ID=24mm H=110mm	
VOLTSP9261	SPRING PIN	SUSPENSION	VOLVO	F, FL	1598764, 1576943	H=160mm M24x3	



NAMES, NUMBERS, SYMBOLS, DESCRIPTIONS LISTED IN THIS DOCUMENT ARE USED FOR REFERENCE PURPOSE ONLY AND IT IS NOT IMPLIED THAT ANY PARTS LISTED IS THE PRODUCT OF THESE MANUFACTURERS.

TC CODE	DESCRIPTION	GROUP	MAKE	MODEL	OE REFERENCE	REMARK	PICTURE
VOLTSP9262	SPRING PIN	SUSPENSION	VOLVO	F, FL	1598765	M24x3	
VOLTSP9274	SPRING PIN	SUSPENSION	VOLVO	FH, FM	1075726	OD=45mm H=105mm M34x4	
VOLTA9305B	SPRING REPAIR KIT	SUSPENSION	VOLVO	FH, FM	1076334S	OD=34mm H=170mm M34X4	
MTA7725B	RUBBER BUSH	SUSPENSION	VOLVO	FE6, FE7	6879332	OD=50mm ID=16mm H=95mm	
VOLTA8622B	STABILIZER BUSH	SUSPENSION	VOLVO	FH	20442252	OD=154mm ID=81mm H=71mm	
TC004D	SPRING MOUNTING	SUSPENSION	VOLVO	A40	11050950, 11119260		
TSM003	SPRING MOUNTING	SUSPENSION	VOLVO	FH, F, FE	1629553, 8151413, 1622982, 1609657, 1577873, 1089501	A= 150 B= 196 h= 150	
VOETSM8579	SPRING MOUNTING	SUSPENSION	VOLVO	A30, A30C, A35, A35C, A40D, A40E T450D	11118579, 11121340, 15169632		
VOLTSM5079	SPRING MOUNTING	SUSPENSION	VOLVO	A35E, A40E, A35F, A40F	11195079, 15167172		
VOLTA12825B	BUSH	SUSPENSION	VOLVO	FH, FM, FL, F	1591023	OD=220mm ID=170mm H= 99,5mm	



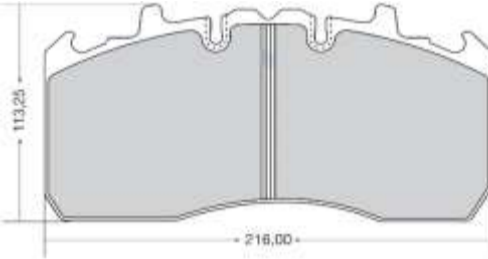
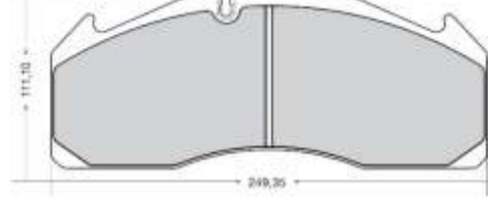
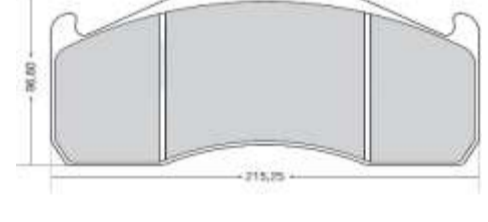
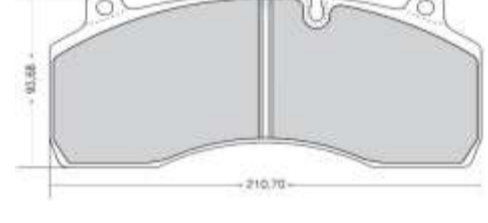
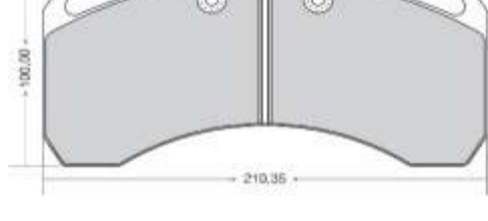
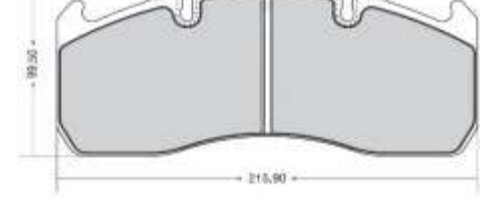
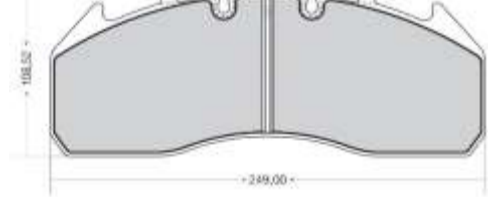
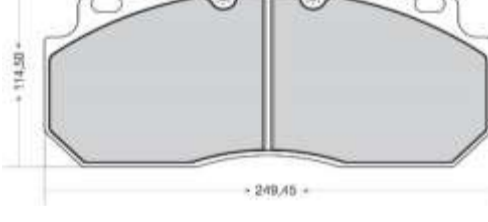

TC CODE	DESCRIPTION	GROUP	MAKE	MODEL	OE REFERENCE	REMARK	PICTURE
VOLTA10423B	STABILIZER BUSH	SUSPENSION	VOLVO	FH, FM, FL	1079225	OD=100mm ID=58mm H=78mm	
VOLTA1194B	STABILIZER BUSH	SUSPENSION	VOLVO	B - SERIES	70301194, 3028447, 9518272, 1135109	OD=80mm ID=45mm H=95mm	
VOLTA8595B	STABILIZER BUSH	SUSPENSION	VOLVO	FH, B	9519245	OD=90mm ID=59mm H=95mm	
VOLTA8814B	STABILIZER BUSH	SUSPENSION	VOLVO	FH, FM, FMX	20428167	OD=63mm ID=42mm H=55mm	
VOLTA8103B	STABILIZER PLASTIC	SUSPENSION	VOLVO	FH, FM, F	1581543	OD=173mm ID=130mm H=82mm	
VOLTA8108B	STABILIZER PLASTIC	SUSPENSION	VOLVO	FH, FM	1075180	ID=45mm 78x89	
VOLTA8110B	STABILIZER PLASTIC	SUSPENSION	VOLVO	FH, FL, F, FM	16050478	OD=90mm ID=60mm H=96mm	
VOLTA8008B	STABILIZER RUBBER	SUSPENSION	VOLVO	F10, F12	1573032	OD=71mm ID=50mm H=105mm	
VOLTA8009B	STABILIZER RUBBER	SUSPENSION	VOLVO	FH, FM	1629169	OD=82mm ID=60mm H=97mm	
VOLTA8812B	STABILIZER BUSH	SUSPENSION	VOLVO	FH, FM	20428165	OD=63mm ID=30mm H=55mm	

NAMES, NUMBERS, SYMBOLS, DECEPTIONS LISTED IN THIS DOCUMENT ARE USED FOR REFERENCE PURPOSE ONLY AND IT IS NOT IMPLIED THAT ANY PARTS LISTED IS THE PRODUCT OF THESE MANUFACTURERS.

TC CODE	DESCRIPTION	GROUP	MAKE	MODEL	OE REFERENCE	REMARK	PICTURE
VOLTM11667	RUBBER BUFFER	CAB	VOLVO	FH, FM	20429148, 21333684	OD=65mm ID=40mm H=60mm	
VOLTM9034	RUBBER BUFFER	CAB	VOLVO	FM, FL, F	1089014	OD=40mm H=70mm	
TM270	REPAIR KIT	CAB	VOLVO	FH, FM	20390840S1	OD=90mm ID=16mm H=70mm	
VOLTCC9431	CAB CYLINDER	CAB	VOLVO	FH, FM	3198843, 20922305		
VOLTCC8460	CAB CYLINDER	CAB	VOLVO	FH, FM	20922303, 20922308, 3198842	D=Ø60 Ax=677	
VOLTHP9414	HAND PUMP	CAB	VOLVO	FH	20917279, 20455262		
VOLTHP11656	HAND PUMP	CAB	VOLVO	FH, FM, FMX	20917278, 20455259		
VOLTHP11657	HAND PUMP	CAB	VOLVO	F, FL	1611186, 3943330	M10 x 1,5 M14 x 1,5  <b>Manual</b>	
VOLTCL11634	CAB LOCK CABLE	CAB	VOLVO	FH, FM	20922589	L=573mm	
VOLTPS11023	PRESSURE SPRING	CAB	VOLVO	FM	8191439	640-200N	

TC CODE	DESCRIPTION	GROUP	MAKE	MODEL	OE REFERENCE	REMARK	PICTURE
VOLTPS8386	PRESSURE SPRING	CAB	VOLVO	FH	1619106	530 MM 150 N	
DPD011	EREN BRAKE PAD	CLUTCH & BRAKE	VOLVO		WVA: 29211	Length=216mm Width=113.25mm Thickness=29.5mm <b>Rear</b>	
DPD125	EREN BRAKE PAD	CLUTCH & BRAKE	VOLVO	FH, FM, FL	20918891, 20931343, 27068092, 3095396, 21088907, WVA: 29125	Length=249.35mm Width=111.1mm Thickness=29.2mm <b>Front &amp; Rear</b>	
DPD137	EREN BRAKE PAD	CLUTCH & BRAKE	VOLVO	FH, FM, FMX	20768101, 3099533, WVA: 29151	Length=215.25mm Width=96.6mm Thickness=29mm <b>Rear</b>	
DPD147	EREN BRAKE PAD	CLUTCH & BRAKE	VOLVO	FL	20780788, 20844903, WVA: 29147	Length=210.7mm Width=93.68mm Thickness=29.5mm <b>Front &amp; Rear</b>	
DPD169	EREN BRAKE PAD	CLUTCH & BRAKE	VOLVO	FH, FM, FMX	20526570, 20560415, 20568713, 20586713, 20765963, 21496552, WVA: 29169	Length=210.35mm Width=100mm Thickness=30mm <b>Front</b>	
DPD173	EREN BRAKE PAD	CLUTCH & BRAKE	VOLVO	FH, FM, FL, FE	20568715, 20568712, 21352573, 21496551, WVA: 29173	Length=215.9mm Width=99.5mm Thickness=29.25mm <b>Front &amp; Rear</b>	
DPD174	EREN BRAKE PAD	CLUTCH & BRAKE	VOLVO	FH, FM, FMX, FE	21024702, 21496550, 21352570, 20568711, 20568714, WVA: 29174	Length=249mm Width=108.52mm Thickness=29.5mm <b>Front &amp; Rear</b>	
D950	EREN BRAKE PAD	CLUTCH & BRAKE	VOLVO	B - SERIES	20825594, 20850194, 3093919, 3093939, 85105485, WVA: 29090	Length=249.45mm Width=114.5mm Thickness=28mm <b>Front</b>	
104068-1	EATON CLUTCH	CLUTCH & BRAKE	VOLVO	FH, FM	9119-000-900-RB 3400700343	Gearbox: VTO2214B	









NAMES, NUMBERS, SYMBOLS, DECEPTIONS LISTED IN THIS DOCUMENT ARE USED FOR REFERENCE PURPOSE ONLY AND IT IS NOT IMPLIED THAT ANY PARTS LISTED IS THE PRODUCT OF THESE MANUFACTURERS.

TC CODE	DESCRIPTION	GROUP	MAKE	MODEL	OE REFERENCE	REMARK	PICTURE
104085-1	EATON CLUTCH	CLUTCH & BRAKE	VOLVO	FH, FM	8112191, 9125-000-900-RB, 3400043032	Gearbox: SR1700 / SR1900	
104461-1	EATON CLUTCH	CLUTCH & BRAKE	VOLVO	FH	3400700359	Gearbox: Kerex / FH / AT	
7003590206	HAMMER CLUTCH	CLUTCH & BRAKE	VOLVO	FH	3400700359	Gearbox: Kerex / FH / AT	
7003430216	HAMMER CLUTCH	CLUTCH & BRAKE	VOLVO	FH, FM	3400700343	Gearbox: VTO2214B	

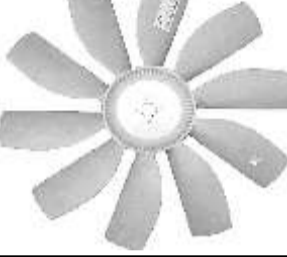
# OTHER / UNIVERSAL GROUP

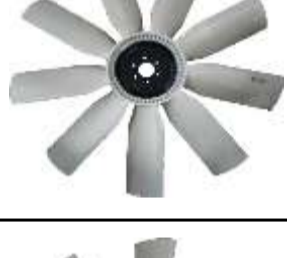
## INDEX

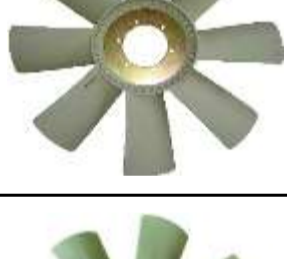
<u>GROUP</u>		<u>PAGES</u>
COOLING GROUP	160	161
SUSPENSION GROUP	161	161
CLUTCH & BRAKE GROUP	161	161

TC CODE	DESCRIPTION	GROUP	MAKE	MODEL	OE REFERENCE	REMARK	PICTURE
TF041	BORGWARNER FAN	COOLING	UNIVERSAL	UNIVERSAL	NA	OD=600mm PCD=152mm ID=127mm 6 Holes	
TF050	BORGWARNER FAN	COOLING	UNIVERSAL	UNIVERSAL	NA	OD=620mm PCD=60mm PCD=50mm ID26mm 4 Holes	
UNITF051	BORGWARNER FAN	COOLING	UNIVERSAL	UNIVERSAL	NA	OD=765mm PCD=64mm ID=42mm 4 Holes	
TF022	BORGWARNER FAN	COOLING	UNIVERSAL	UNIVERSAL	NA	OD=765mm ID=125mm PCD=146mm PCD=152mm 6 Holes	
TF047	BORGWARNER FAN	COOLING	UNIVERSAL	UNIVERSAL	NA	OD=720mm ID=65mm PCD=89mm 6 Holes	
TF048	BORGWARNER FAN	COOLING	UNIVERSAL	UNIVERSAL	NA	OD=920mm ID=50mm PCD=89mm 6 Holes	
TF049	BORGWARNER FAN	COOLING	UNIVERSAL	UNIVERSAL	NA	OD=960mm ID=50mm PCD=89mm 6 Holes	
TVF000	BORGWARNER FAN	COOLING	UNIVERSAL	UNIVERSAL	NA	OD=760mm PCD=152mm ID=127mm 6 Holes	
TVF027/B	FAN	COOLING	UNIVERSAL	UNIVERSAL	NA	OD=750mm PCD=200mm ID=180mm 6 Holes  <b>BLOWER</b>	
TVF126	BORGWARNER FAN	COOLING	UNIVERSAL	UNIVERSAL	NA	OD=740mm PCD=152mm ID=127mm 6 Holes	













TC CODE	DESCRIPTION	GROUP	MAKE	MODEL	OE REFERENCE	REMARK	PICTURE
TVD039	BORGWARNER VISCIOUS	COOLING	UNIVERSAL	UNIVERSAL	NA	<b>Fan Side:</b> ID=127mm PCD=152mm 6 Holes <b>Engine Side:</b> M30	
TVD039FM	FAN MARKET VISCIOUS	COOLING	UNIVERSAL	UNIVERSAL	NA	<b>Fan Side:</b> ID=127mm PCD=152mm 6 Holes <b>Engine Side:</b> M30	
TVD154	BORGWARNER VISCIOUS	COOLING	UNIVERSAL	UNIVERSAL	NA	<b>Fan Side:</b> ID=82mm PCD=97mm 4 Holes <b>Engine Side:</b> M30	
TVD154FM	FAN MARKET VISCIOUS	COOLING	UNIVERSAL	UNIVERSAL	NA	<b>Fan Side:</b> ID=82mm PCD=97mm 4 Holes <b>Engine Side:</b> M30	
TA248B	BUSH	SUSPENSION	UNIVERSAL	UNIVERSAL	NA	OD=95mm Hole ID=21mm PCD=130mm  1=VOLTA8616B	
D158	EREN BRAKE PAD	CLUTCH & BRAKE	KNORR		WVA: 29158	Length=210.7mm Width=108mm Thickness=29.5mm  <b>Rear</b>	

# TRAILER GROUP



## INDEX

<u>GROUP</u>		<u>PAGES</u>
STEERING GROUP	163	163
SUSPENSION GROUP	163	165
CLUTCH & BRAKE GROUP	165	166
AXLE / DIFFERENTIAL & SHAFT GROUP	166	166



TC CODE	DESCRIPTION	GROUP	MAKE	MODEL	OE REFERENCE	REMARK	PICTURE
TS13617	TIE ROD END	STEERING GROUP	BPW	BPW	218081200	Taper 1=34,3mm Taper 2=38mm M38  <b>Left Hand</b>	
TS13617	TIE ROD END	STEERING GROUP	SAF	SAF	6851490000	Taper 1=34,3mm Taper 2=38mm M38  <b>Left Hand</b>	
BPWTA7781B	SPRING EYE BUSH	SUSPENSION GROUP	BPW	BPW	0203169000	OD=57mm ID=30mm H=102mm	
BPWTA8025B	SPRING EYE BUSH	SUSPENSION GROUP	BPW	BPW	0203159800	OD=60mm ID=30mm H=72mm	
SAFTA7787B	SPRING EYE BUSH	SUSPENSION GROUP	SAF	SAF	4177301000	OD=68mm ID=30mm H=104mm	
10253	SPRING EYE BUSH	SUSPENSION GROUP	BPW	BPW	0203142400	OD=60mm ID=24mm H=72mm	
10254	REPAIR KIT	SUSPENSION GROUP	BPW	BPW	0585700180	M30x170 L=125 / 120mm ID=30mm	
1255	REPAIR KIT	SUSPENSION GROUP	BPW	BPW	0585700150	M30x200 L=125 / 121mm ID=30mm	
10257	REPAIR KIT	SUSPENSION GROUP	BPW	BPW	0585700120	M30x200	
10258	REPAIR KIT	SUSPENSION GROUP	BPW	BPW	0585700240	M30x200 L=125 / 121mm ID=30mm	

NAMES, NUMBERS, SYMBOLS, DESCRIPTIONS LISTED IN THIS DOCUMENT ARE USED FOR REFERENCE PURPOSE ONLY AND IT IS NOT IMPLIED THAT ANY PARTS LISTED IS THE PRODUCT OF THESE MANUFACTURERS.

TC CODE	DESCRIPTION	GROUP	MAKE	MODEL	OE REFERENCE	REMARK	PICTURE
10909	REPAIR KIT	SUSPENSION GROUP	BPW	BPW	0585700280	M24x170	
BPWTA10287RK	REPAR KIT	SUSPENSION GROUP	BPW	BPW	0980107020	OD=57mm ID=30mm H=102mm	
10222	SPRING BOLT	SUSPENSION GROUP	BPW	BPW	0334105030	M30x3,5x200	
10266	SPRING BOLT	SUSPENSION GROUP	BPW	BPW	0334105040	M30x3,5x200	
10272	METAL BUSHING	SUSPENSION GROUP	BPW	BPW	0311301460	OD=73,5mm ID=30,5mm H=24mm	
10273	METAL BUSHING	SUSPENSION GROUP	BPW	BPW	0311323010	OD=73,6mm ID=30,5 / 42,5mm H=24mm	
14111	METAL BUSHING	SUSPENSION GROUP	BPW	BPW	0311303100	OD=67mm H=22mm	
10224	NUT	SUSPENSION GROUP	BPW	BPW	0326015010, 0252208126, 0252208182	M30x3,5	
10265	PLATE SHEET	SUSPENSION GROUP	BPW	BPW	0316435020	L=125 / 120mm ID=30mm	
10267	PLATE SHEET	SUSPENSION GROUP	BPW	BPW	0316435010	L=125 / 121mm ID=30mm	

TC CODE	DESCRIPTION	GROUP	MAKE	MODEL	OE REFERENCE	REMARK	PICTURE
10263	SPRING PLATE	SUSPENSION GROUP	BPW	BPW	0328154180	L=57,5 / 104,5mm H=8mm	
10225	WASHER	SUSPENSION GROUP	BPW	BPW	0332032380	OD=58mm ID=31mm H=5mm	
SAFTM9401	RUBBER BUFFER	SUSPENSION GROUP	SAF	SAF	4177302800	OD=155mm ID=31,5mm H=114mm	
SAFTM9402	RUBBER BUFFER	SUSPENSION GROUP	SAF	SAF	4177302600	OD=152mm ID=31,5mm H=171mm	
DPD165	EREN BRAKE PAD	CLUTCH & BRAKE GROUP	BPW	TRAILER	0509290040, 0509290050, 0509290100, 0980102750, 0980102930, WVA: 29165	Length=210.4mm Width=92.4mm Thickness=29.5mm <b>Rear</b>	
DPD167	EREN BRAKE PAD	CLUTCH & BRAKE GROUP	BPW	TRAILER	0509290070, 0509290090, 0509290090, 0980106450, 0980106450, 0980107280, WVA: 29167	Length=247.5mm Width=109.5mm Thickness=29.5mm <b>Rear</b>	
DPD171	EREN BRAKE PAD	CLUTCH & BRAKE GROUP	BPW	TRAILER	0980108161, 0509290230, 0980108160, 0980107260, 0980106440, WVA: 29171	Length=210.4mm Width=108mm Thickness=29.5mm <b>Front</b>	
DPD301	EREN BRAKE PAD	CLUTCH & BRAKE GROUP	BPW	TRAILER	0980102750, 0980102750, 0980102750, 0980106210, WVA: 29094	Length=210.7mm Width=92.54mm Thickness=29.5mm <b>Front &amp; Rear</b>	
DPD302	EREN BRAKE PAD	CLUTCH & BRAKE GROUP	BPW	TRAILER	0980107070, WVA: 29148	Length=185.17mm Width=84.3mm Thickness=34mm <b>Front &amp; Rear</b>	
DPD143	EREN BRAKE PAD	CLUTCH & BRAKE GROUP	SAF	TRAILER	3057317900, WVA: 29143	Length=247.6mm Width=108.3mm Thickness=29.5mm <b>Rear</b>	

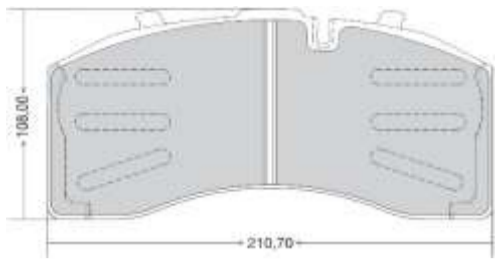
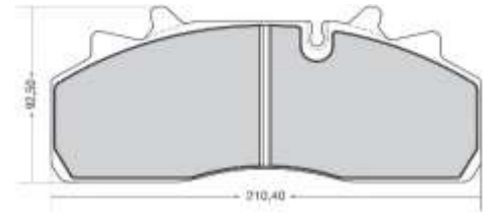
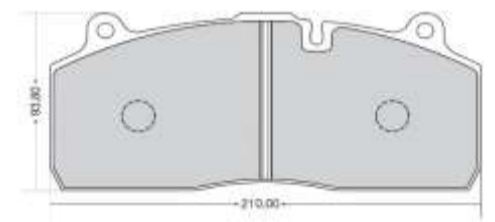
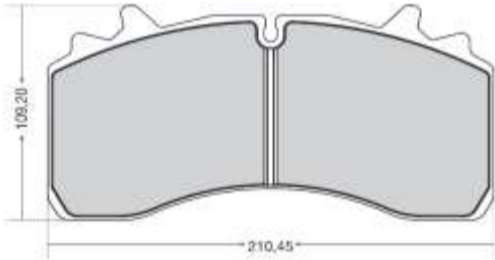
NAMES, NUMBERS, SYMBOLS, DECEPTIONS LISTED IN THIS DOCUMENT ARE USED FOR REFERENCE PURPOSE ONLY AND IT IS NOT IMPLIED THAT ANY PARTS LISTED IS THE PRODUCT OF THESE MANUFACTURERS.

TC CODE	DESCRIPTION	GROUP	MAKE	MODEL	OE REFERENCE	REMARK	PICTURE
DPD158	EREN BRAKE PAD	CLUTCH & BRAKE GROUP	SAF	TRAILER	3057008500, WVA: 29158	Length=210.7mm Width=108mm Thickness=29.5mm  <b>Rear</b>	
DPD159	EREN BRAKE PAD	CLUTCH & BRAKE GROUP	SAF	TRAILER	3057008000, 3057008001, WVA: 29159	Length=210.4mm Width=92.5mm Thickness=28.8mm  <b>Front &amp; Rear</b>	
DPD195	EREN BRAKE PAD	CLUTCH & BRAKE GROUP	SAF	TRAILER	03057009600, 04057439600, WVA: 29195	Length=210mm Width=93.7mm Thickness=30mm  <b>Rear</b>	
DPD303	EREN BRAKE PAD	CLUTCH & BRAKE GROUP	SAF	TRAILER	3057008400, 3057008401, WVA: 29162	Length=210.45mm Width=109.2mm Thickness=30mm  <b>Rear</b>	
14896	REPAIR KIT	CLUTCH & BRAKE GROUP	BPW	BPW	0980102910		
14892	DUST COVER	AXLE / DIFFERENTIAL & SHAFT GROUP	BPW	BPW	0312048150	OD=160mm ID=122mm H=8,5mm	

**DUROLINE BRAKE LININGS AND DISC PADS AVAILABLE FOR ALL COMMERCIAL VEHICLES & TRAILER**



**CONTACT OUR OFFICE FOR PRODUCT IDENTIFICATION**

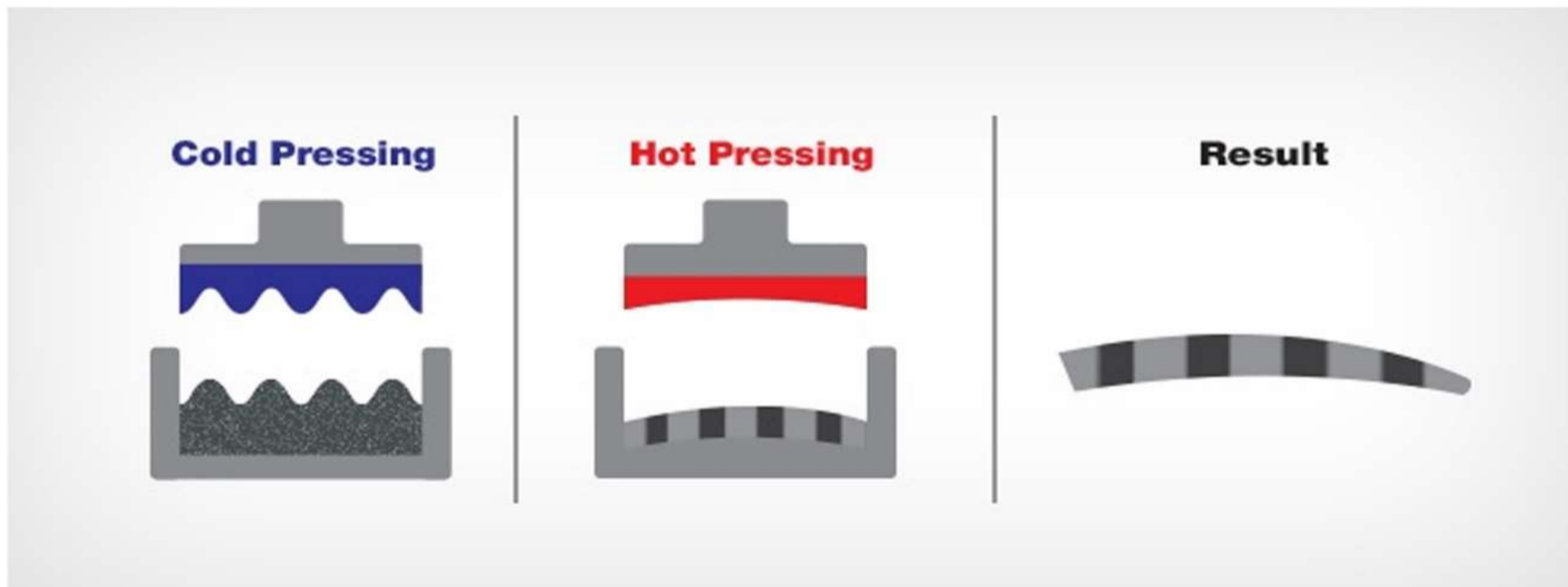

**DUROLINE OFFERS THE INNOVATIVE AND EXCLUSIVE WAVE PROCESS - A PATENTED PROCESS OF MANUFACTURING BRAKE LININGS IN WHICH DIFFERENT DENSITIES ARE CREATED IN THE SAME LINING. THIS EXCLUSIVE TECHNOLOGY ALLOWS TWO OTHERWISE CONFLICTING CHARACTERISTICS OF BRAKE PRODUCTS TO COEXIST:**

**THE HIGH DURABILITY OF HARDER LININGS WITH THE STABLE FRICTION COEFFICIENT OF SOFTER MATERIALS.**

